

Alphabet Tracing

Letter Pairs: Aa

Aa

anchor

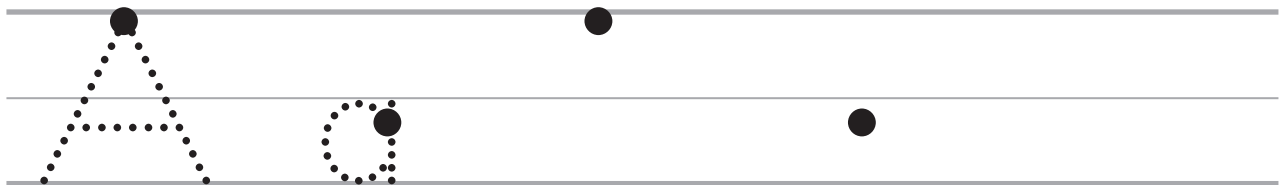
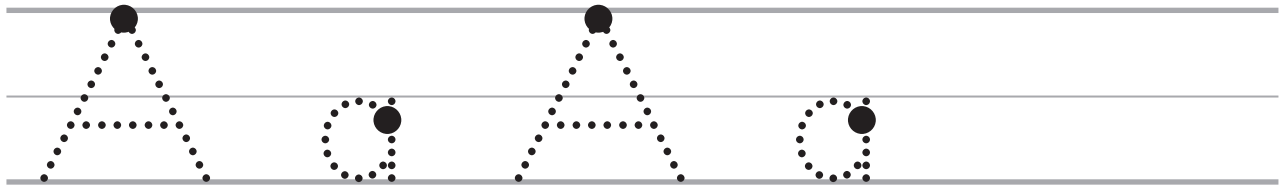
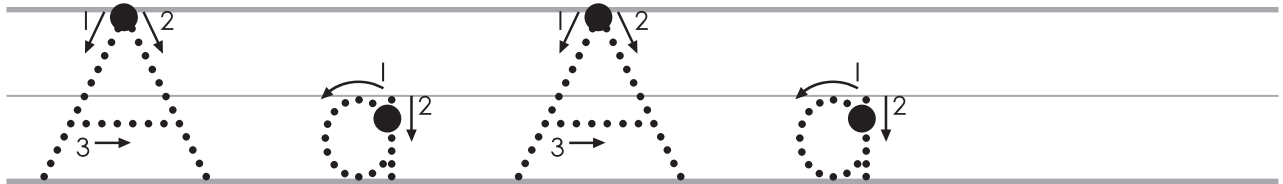
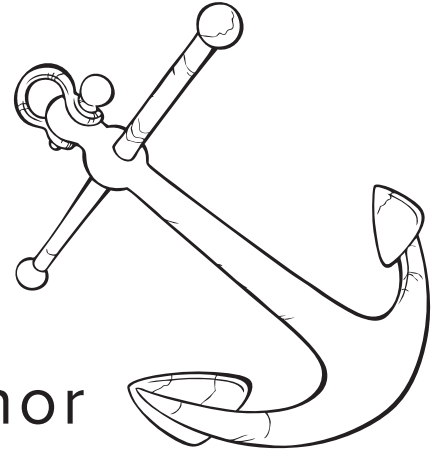

Alphabet
Letter Coloring: **Aa**

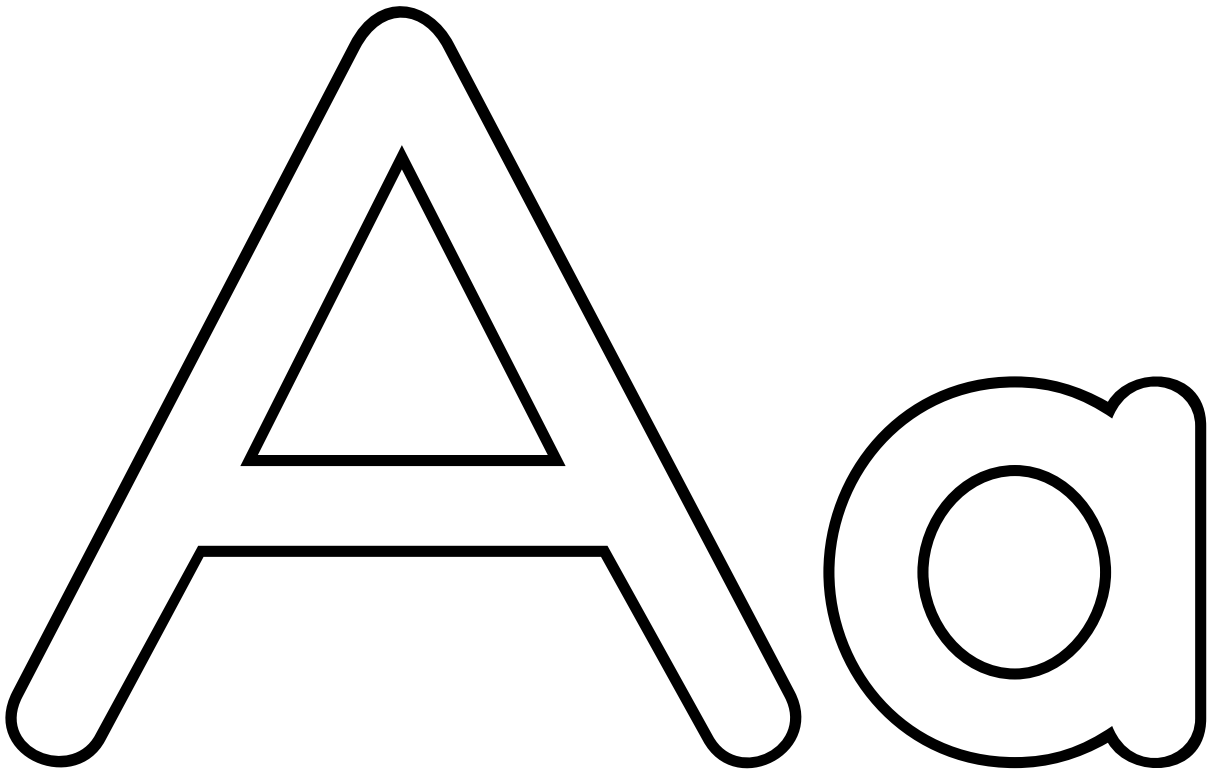

Alphabet Tracing

Letter Pairs: **Bb**

Bb

bicycle

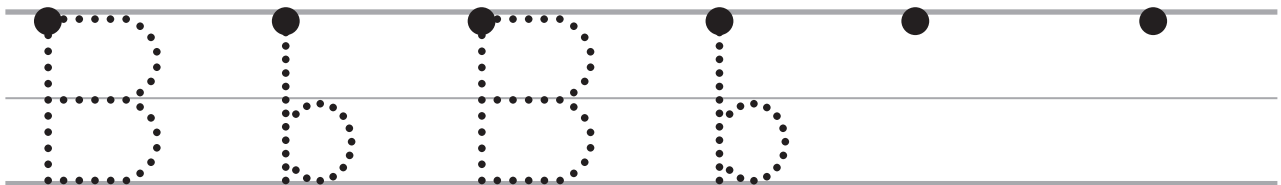
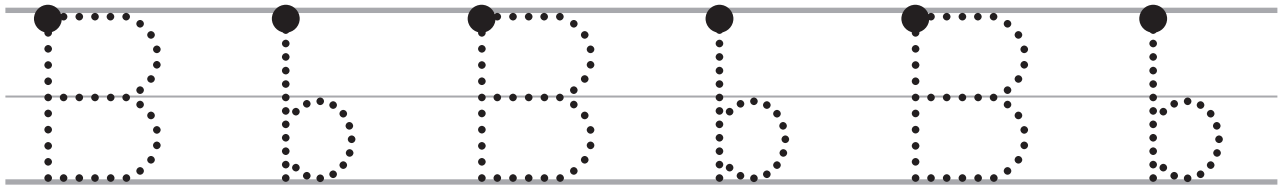
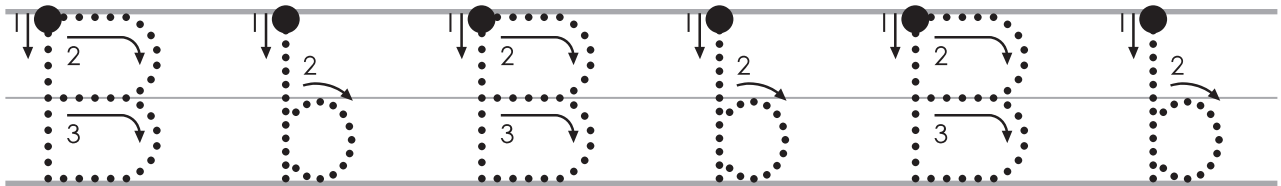
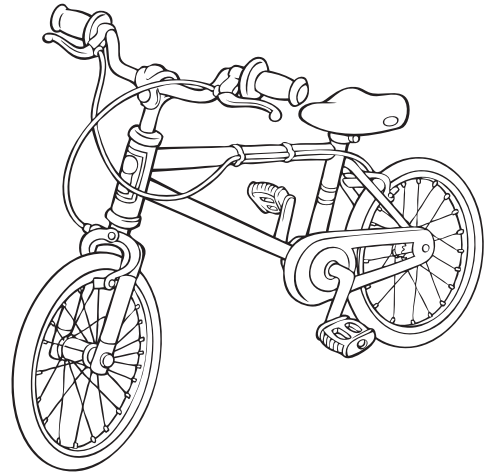

Alphabet

Letter Coloring: **Bb**

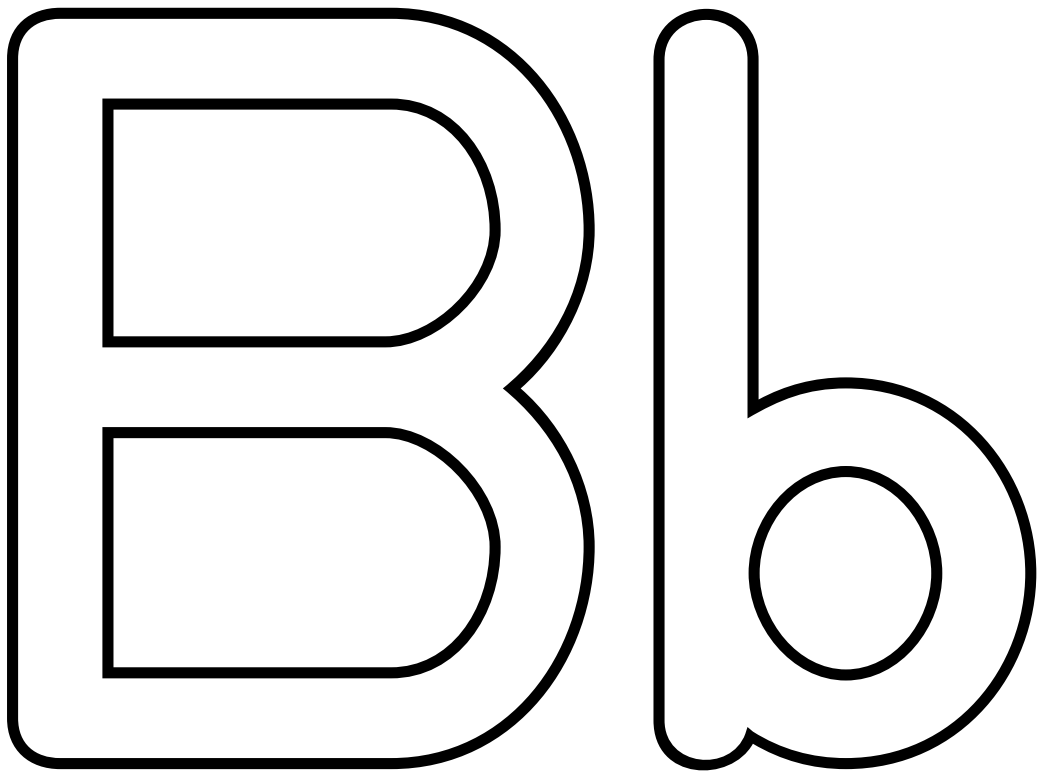

Alphabet Tracing

Letter Pairs: Cc

Cc

COW

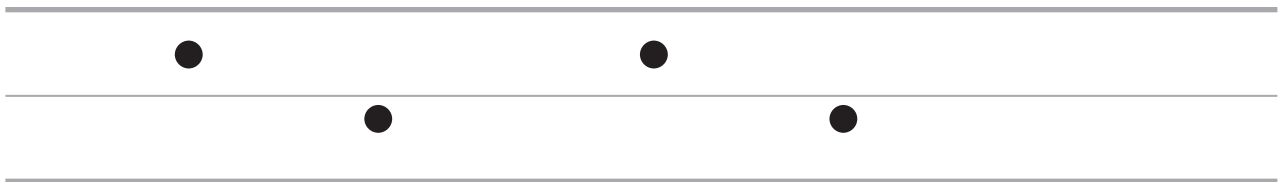
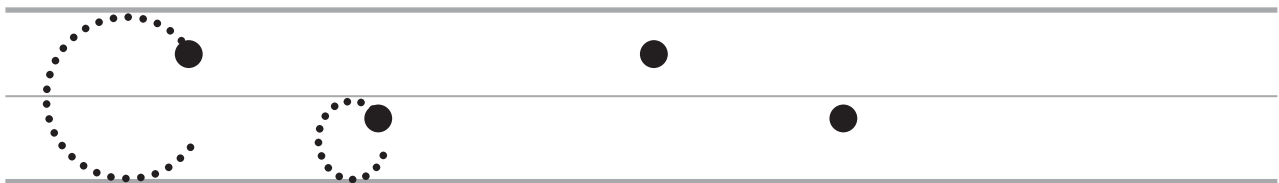
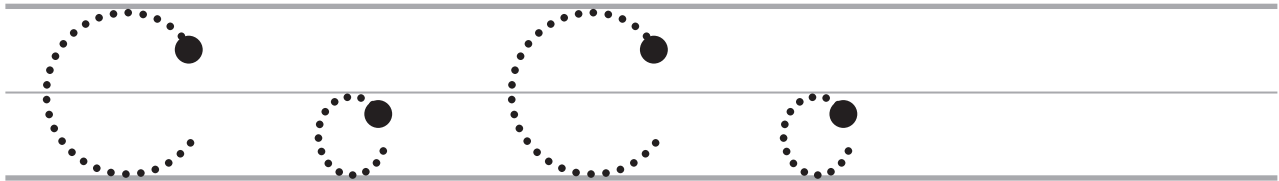
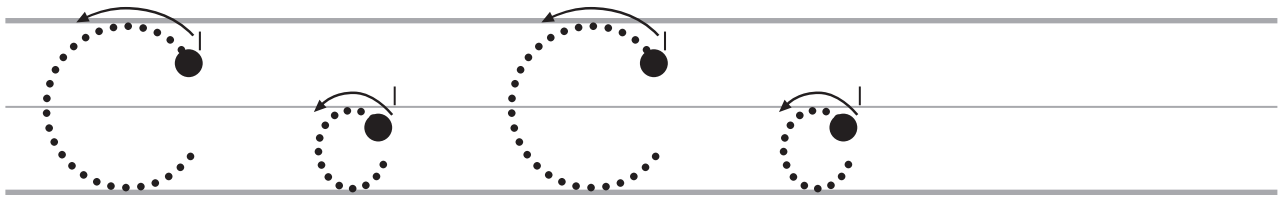
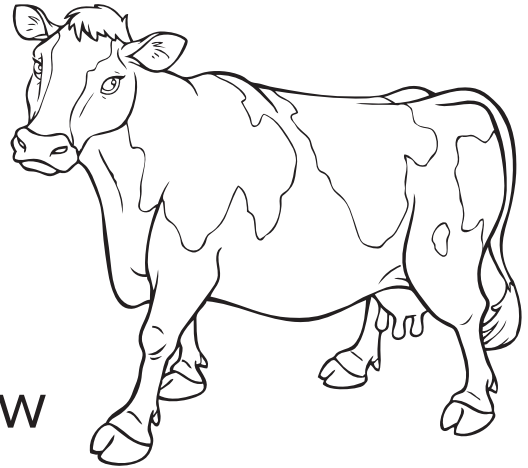

Alphabet
Letter Coloring: **Cc**

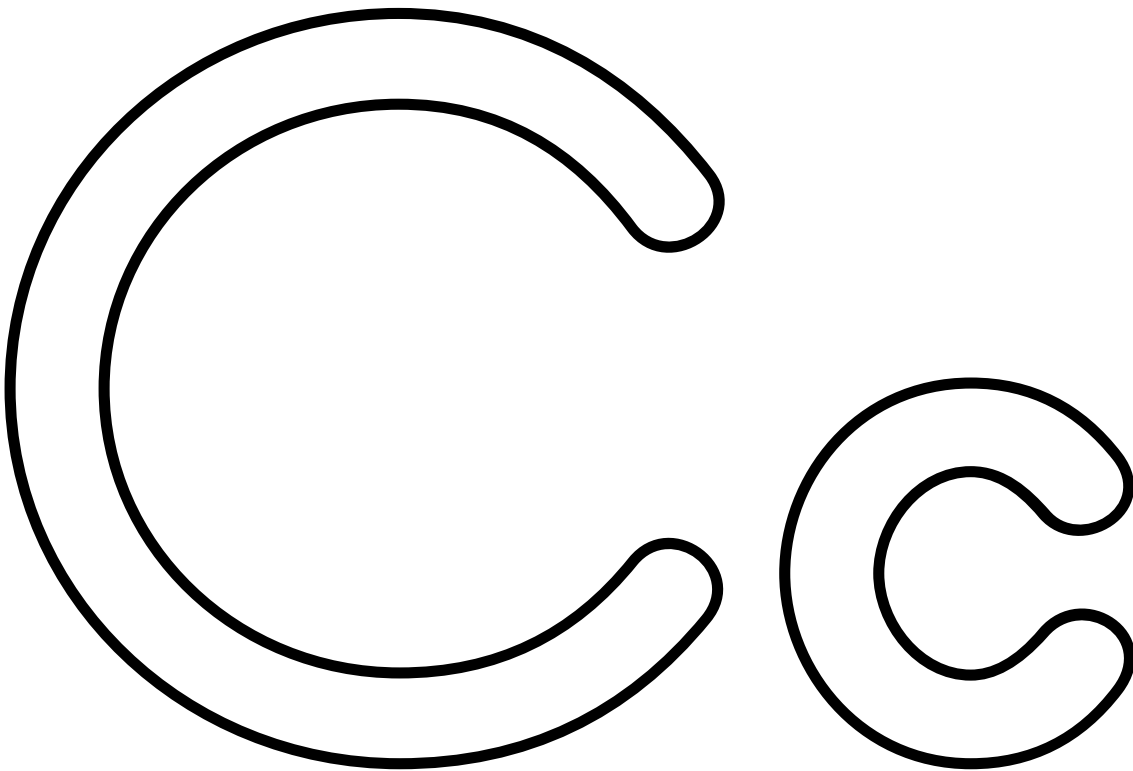

Alphabet Tracing

Letter Pairs: Dd

Dd

doll



Tracing practice area with four rows of handwriting lines. The first row shows dotted letters 'D' and 'd' with numbered arrows indicating stroke order: 'D' is formed by a vertical line down (1) and a curved line (2); 'd' is formed by a counter-clockwise circle (1) and a vertical line down (2). The second row contains dotted 'D' and 'd' for tracing. The third row contains a dotted 'D' and 'd' followed by solid black dots for independent practice. The fourth row contains solid black dots for independent practice.

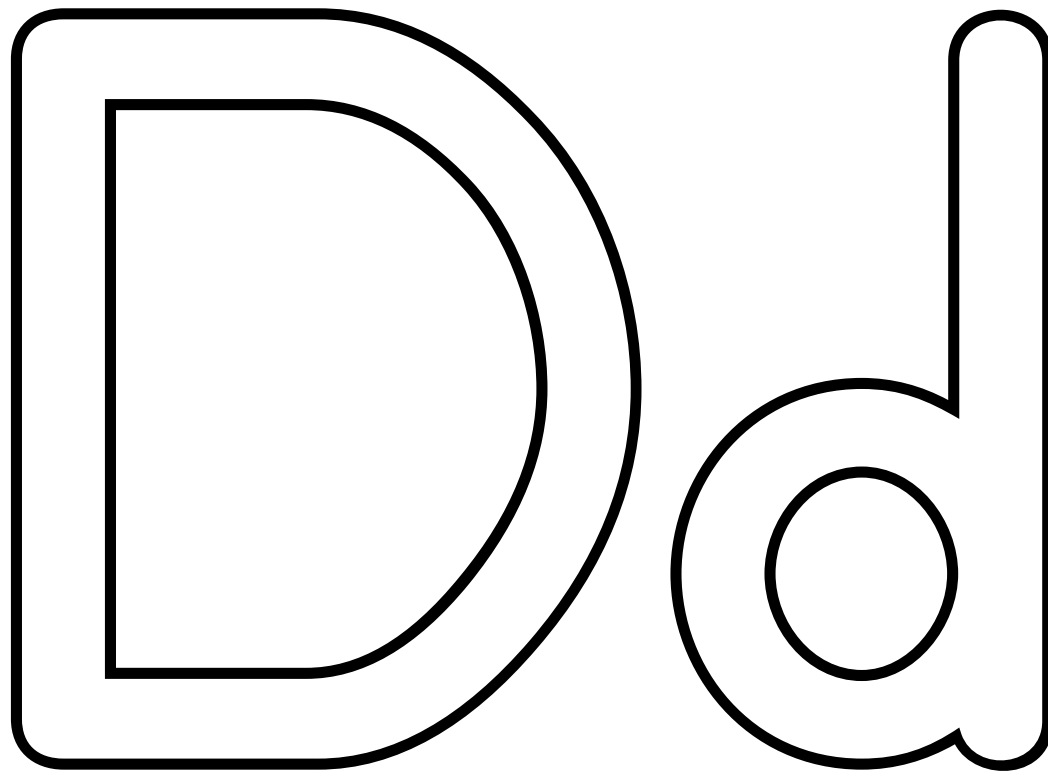

Alphabet Tracing

Letter Pairs: Ee

E e

elephant

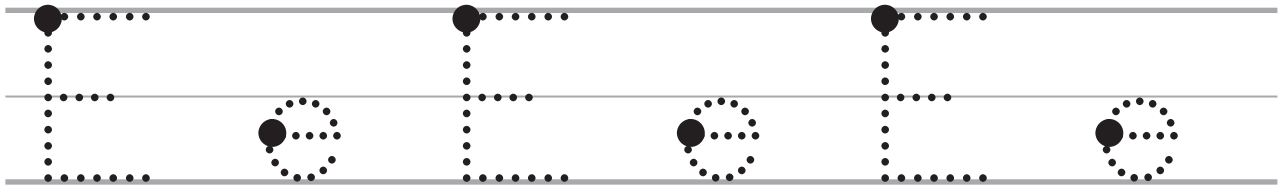
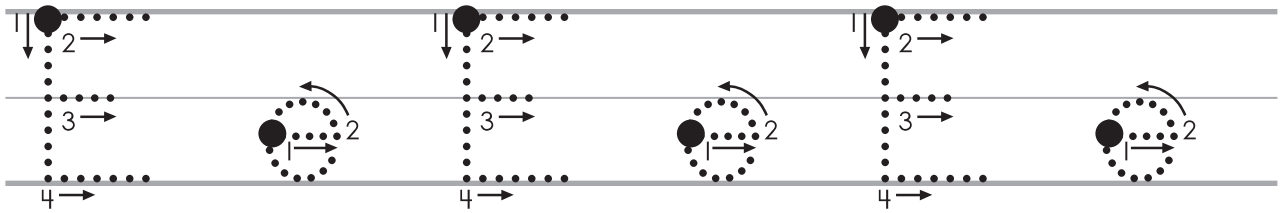
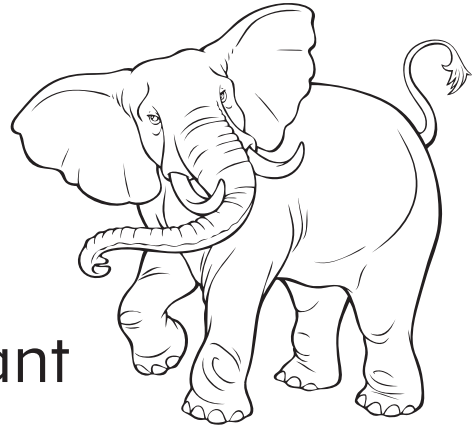



Alphabet Tracing

Letter Pairs: Ff

F f

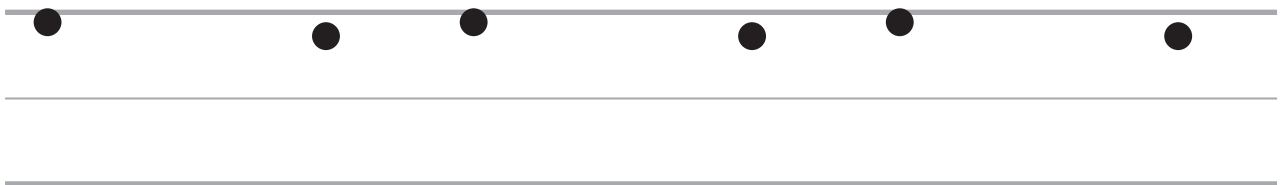
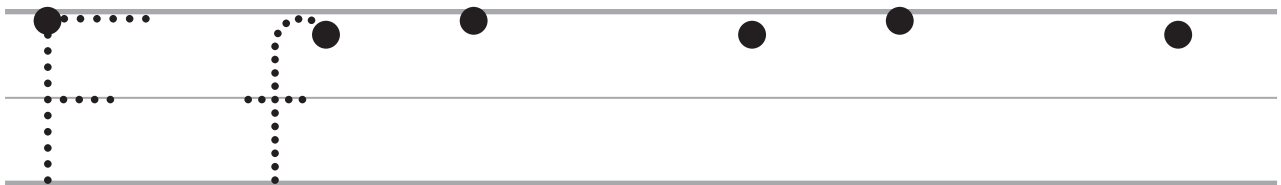
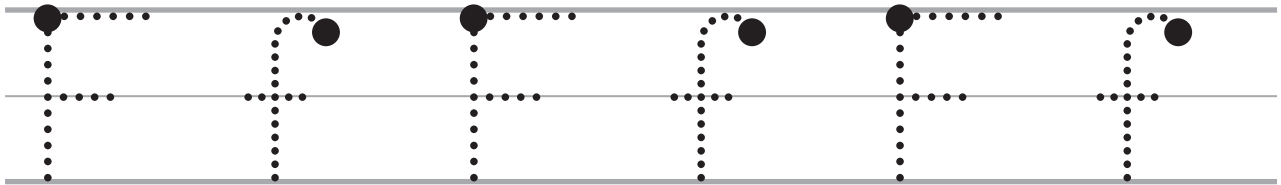
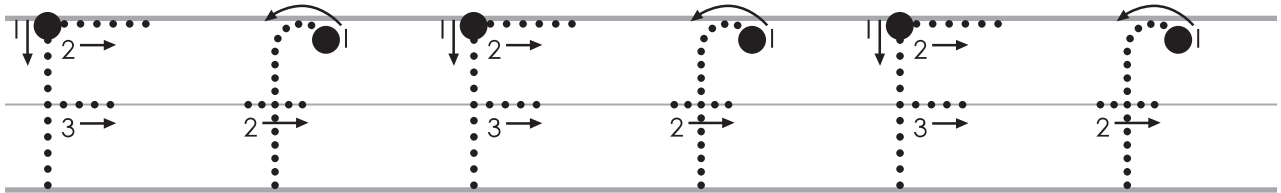
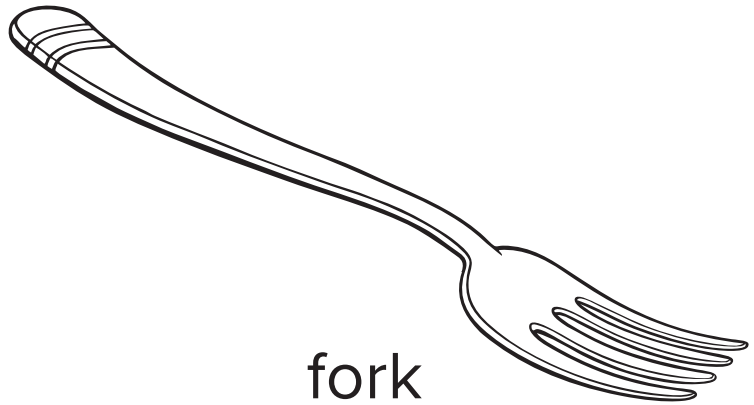

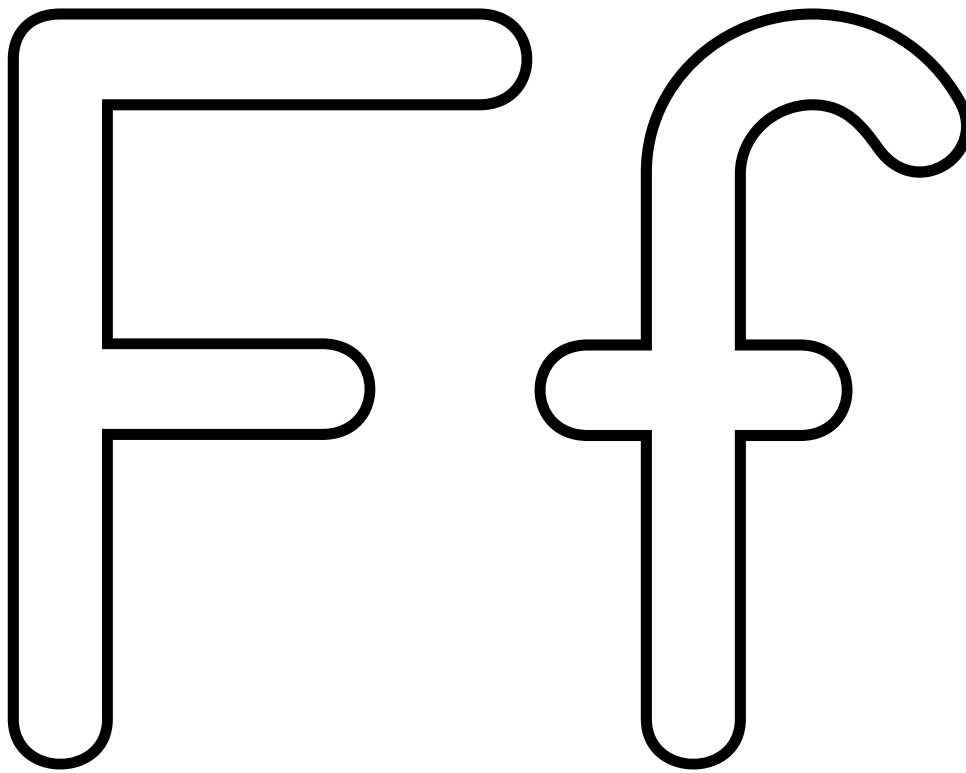

Alphabet Tracing

Letter Pairs: Gg

G

g

goldfish

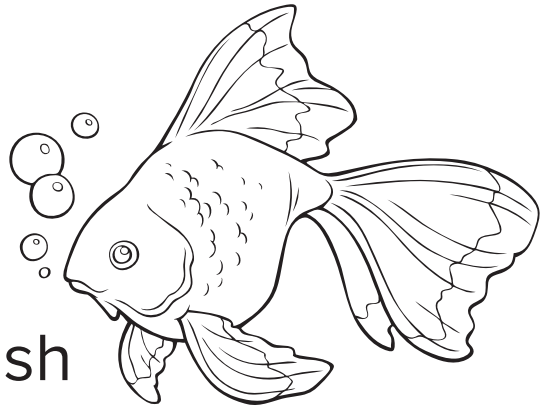

Tracing practice area with four rows of handwriting lines. The first row shows dotted uppercase 'G' and lowercase 'g' with numbered arrows indicating stroke order. The second row shows dotted 'G' and 'g' for tracing. The third row shows a dotted 'G', a dotted 'g', and two solid black dots for independent practice. The fourth row shows two solid black dots for independent practice.

Alphabet
Letter Coloring: **Gg**

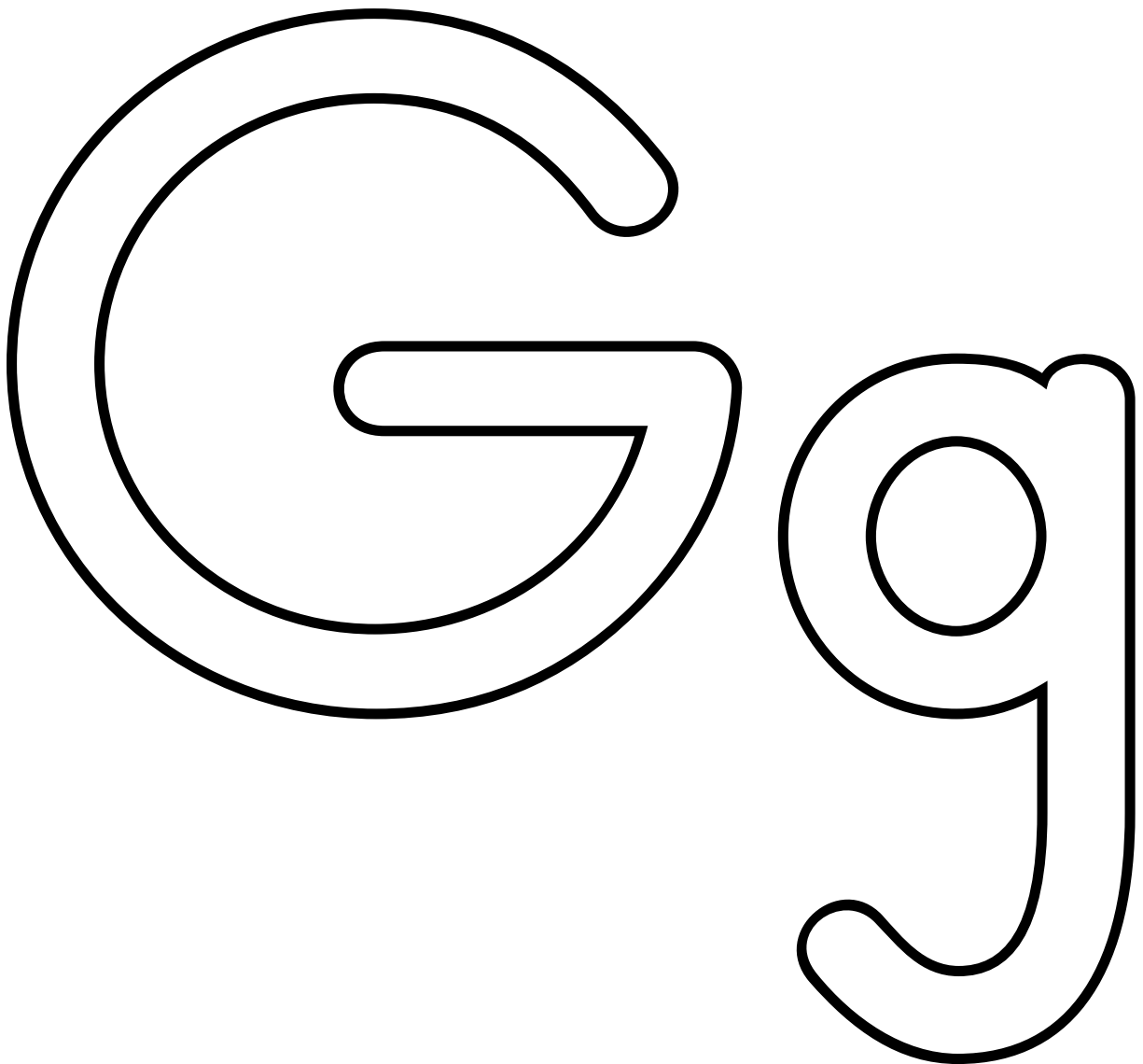

Alphabet Tracing

Letter Pairs: Hh

Hh

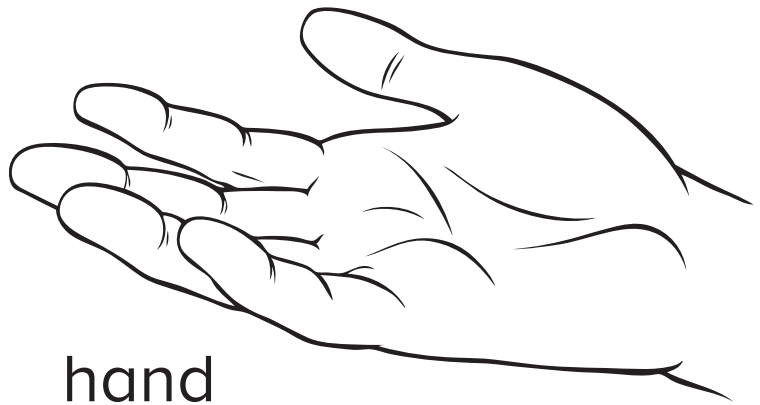

hand

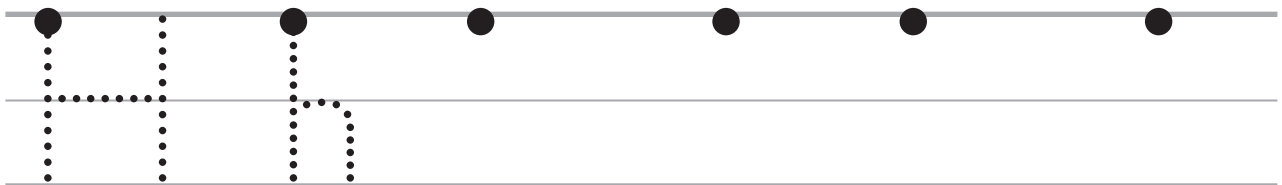
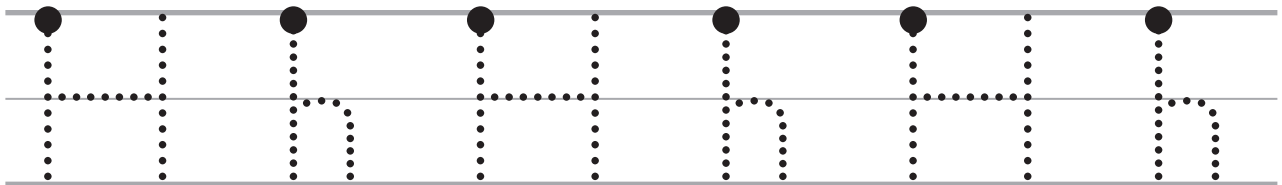
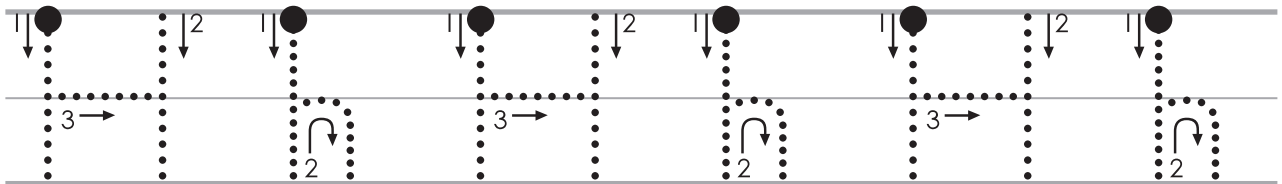

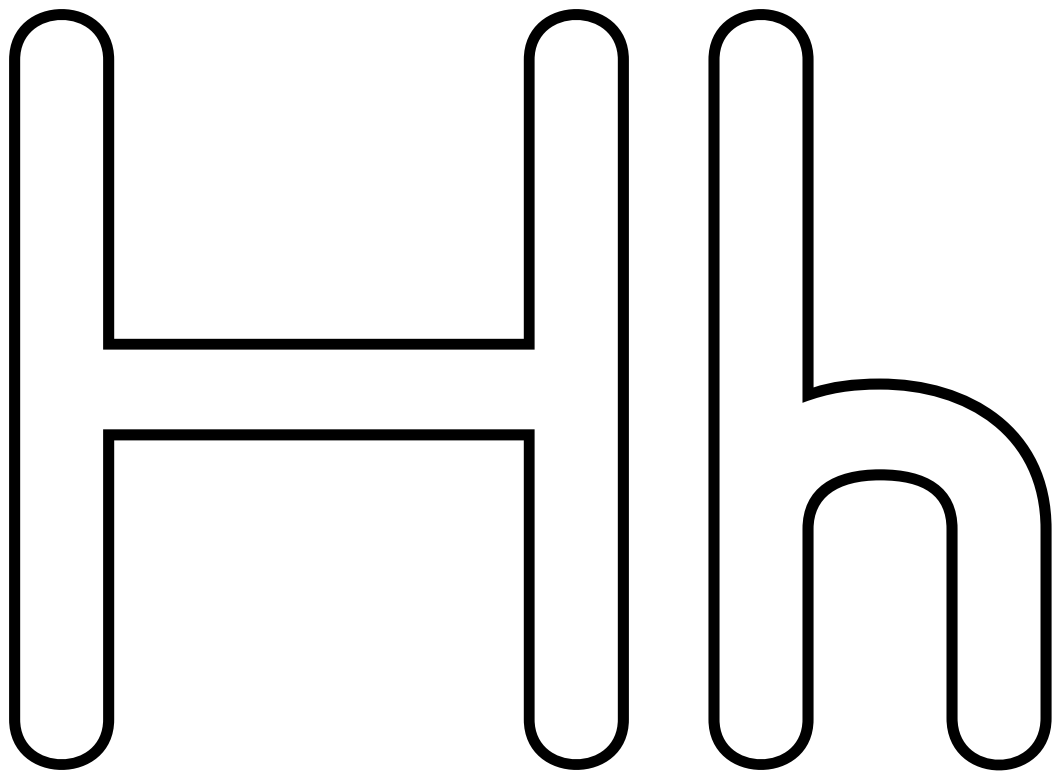

Alphabet Tracing

Letter Pairs: **Ii**

I i

iron

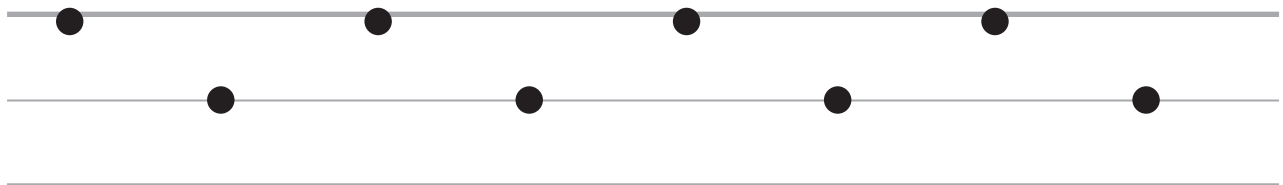
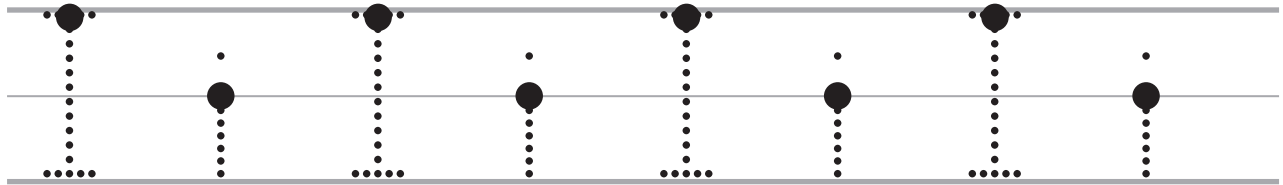
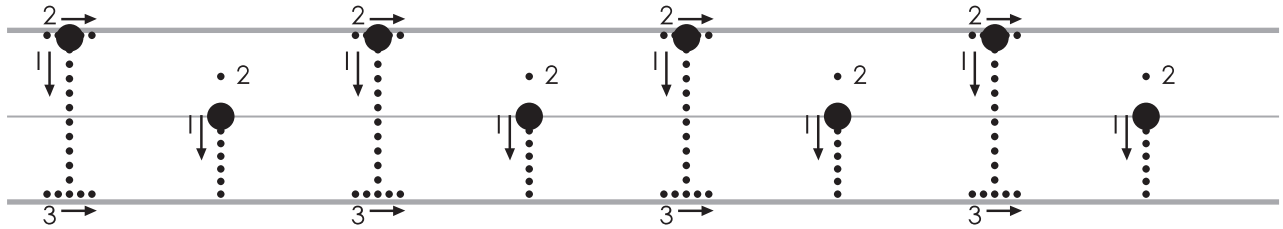
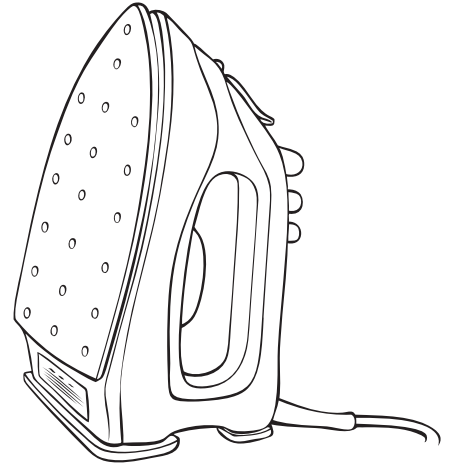

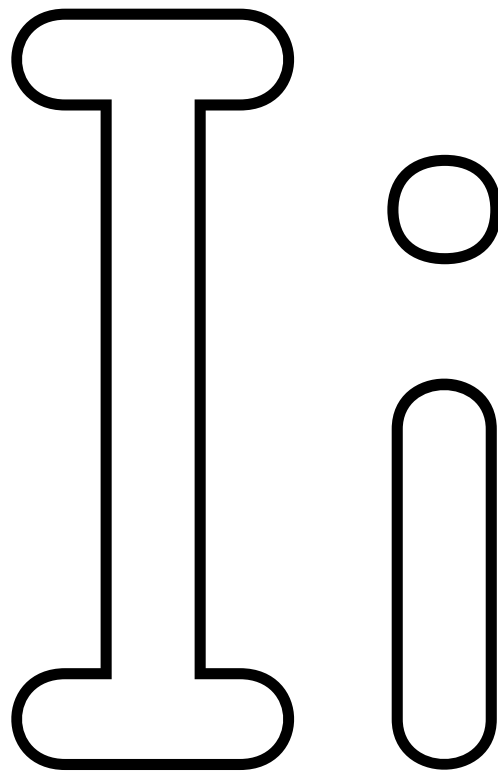

Alphabet
Letter Coloring: **Jj**

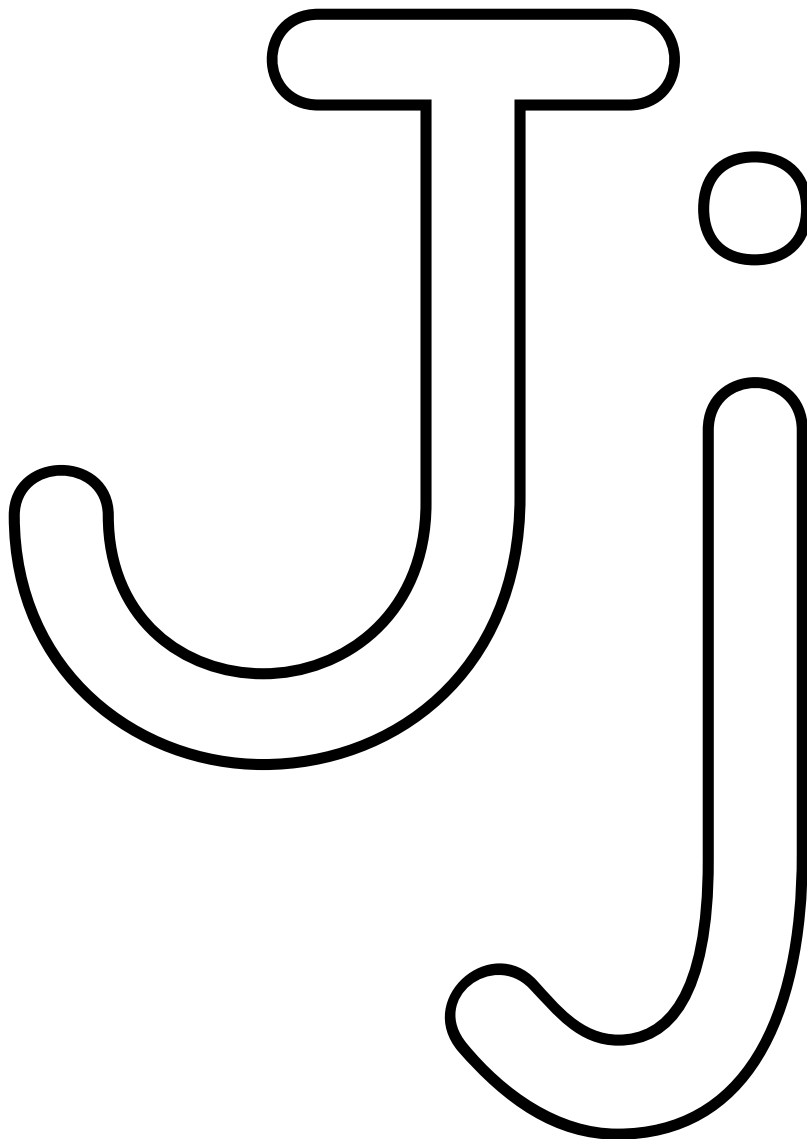

Alphabet Tracing

Letter Pairs: Jj

Jj

jeans



Tracing practice area with four rows of handwriting lines. The first row shows the stroke order for uppercase 'J' and lowercase 'j' with numbered arrows (1 for the main stroke, 2 for the top bar or dot). The second row contains dotted 'J' and 'j' for tracing. The third row contains dotted 'J' and 'j' for tracing. The fourth row contains solid black dots for independent writing practice.

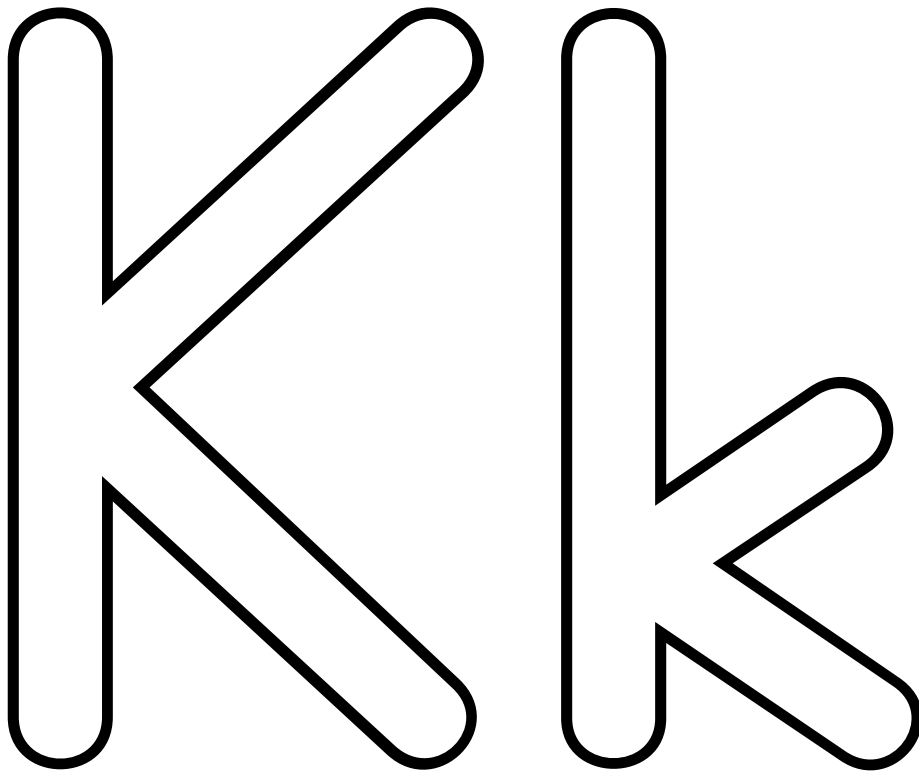

Alphabet Tracing

Letter Pairs: Kk

Kk

kangaroo

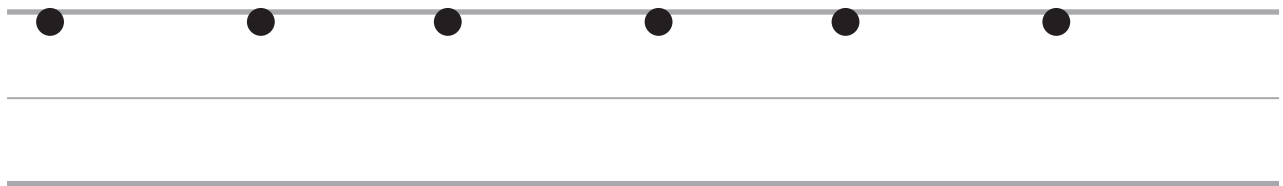
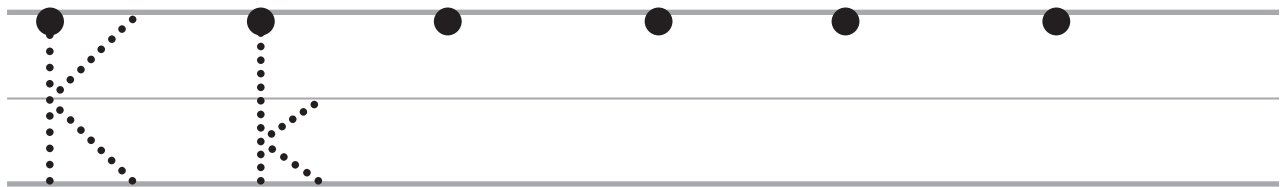
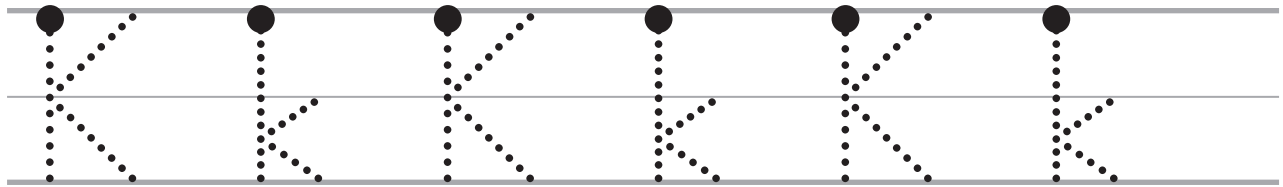
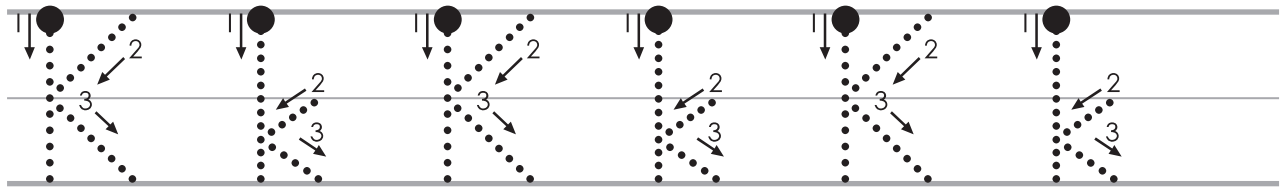

Alphabet
Letter Coloring: LI

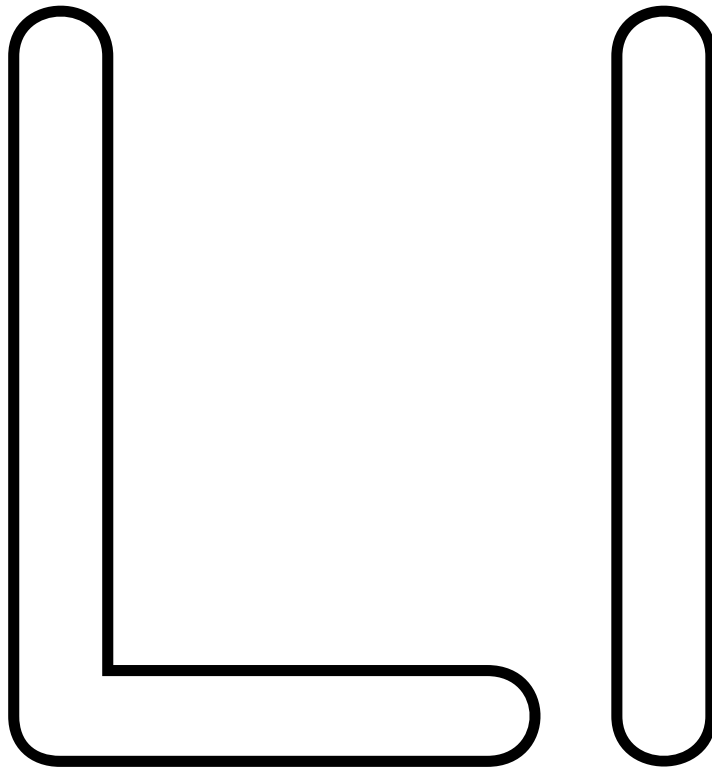

Alphabet Tracing

Letter Pairs: LI

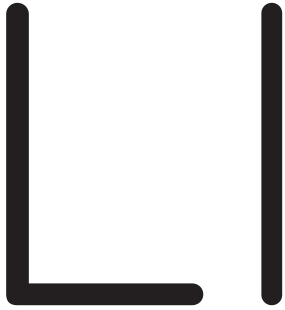

ladder

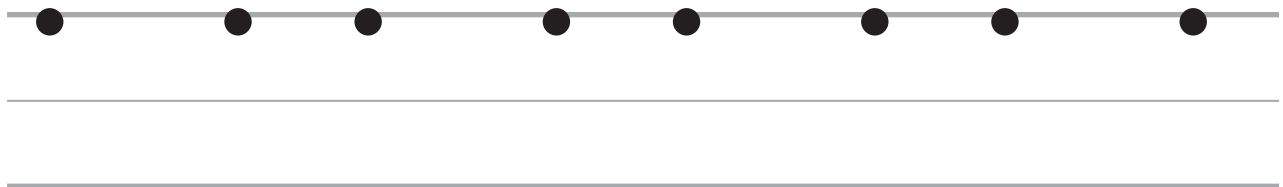
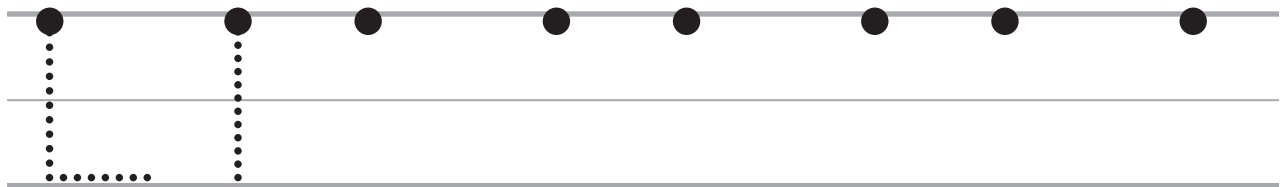
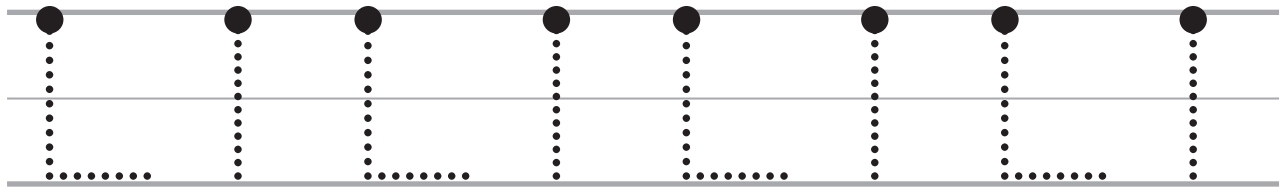
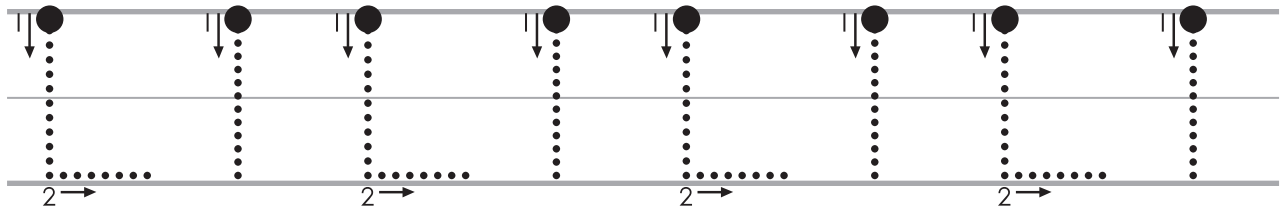



Alphabet Tracing

Letter Pairs: Mm

Mm

mirror

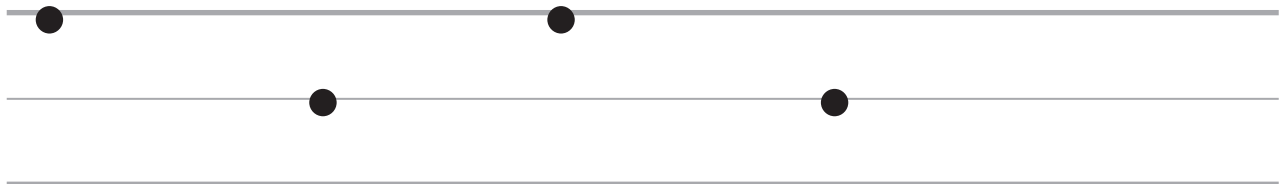
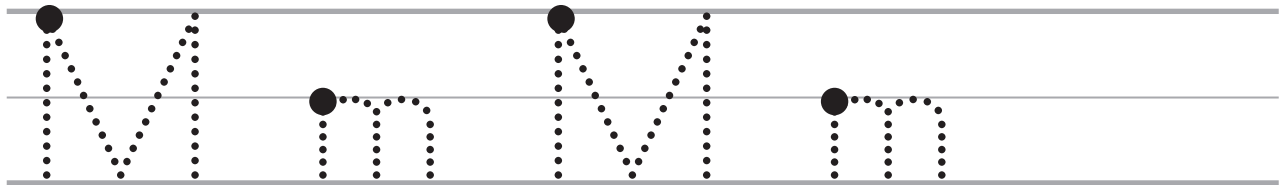
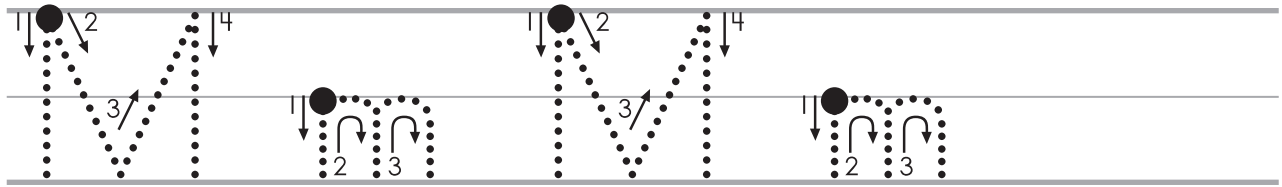
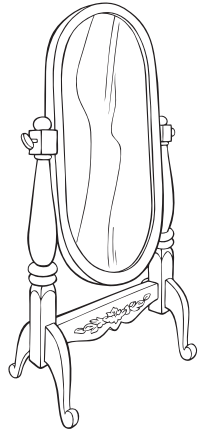

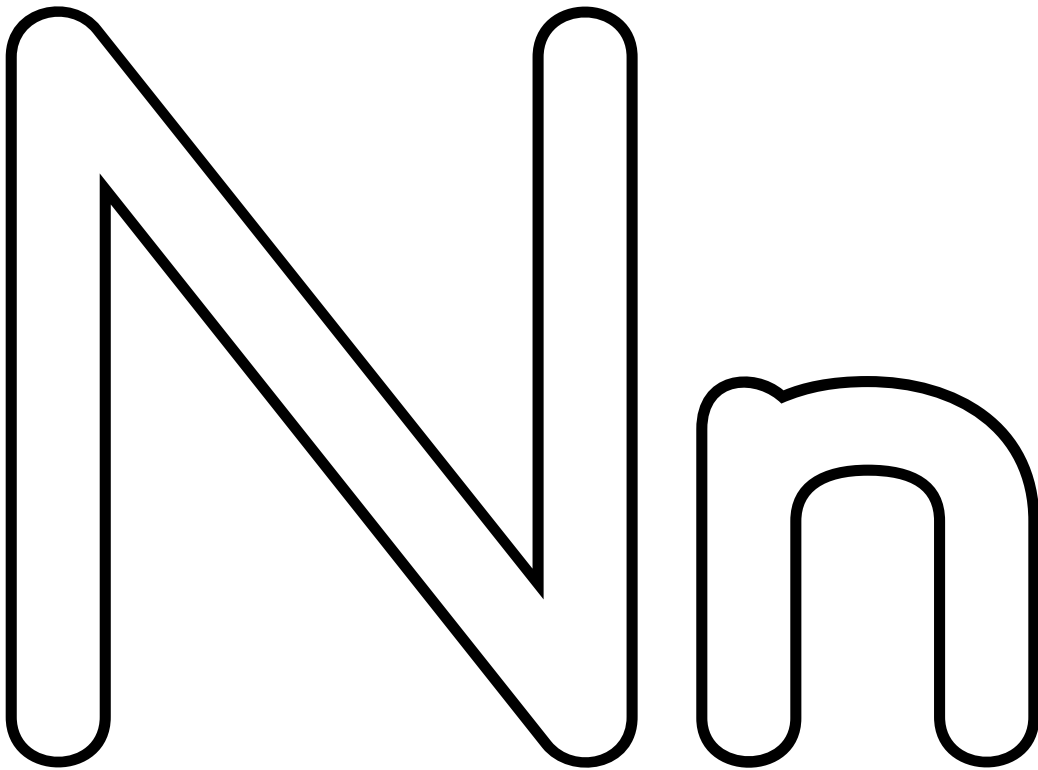

Alphabet Tracing

Letter Pairs: Nn

Nn

necklace



Tracing practice area with four rows of handwriting lines. The first row shows stroke order for uppercase 'N' (1: vertical down, 2: diagonal down-right, 3: vertical down) and lowercase 'n' (1: vertical down, 2: curve down-right). The second row contains dotted 'N' and 'n' for tracing. The third row contains dotted 'N' and 'n' with starting dots. The fourth row contains starting dots for independent writing.

Alphabet
Letter Coloring: **Oo**

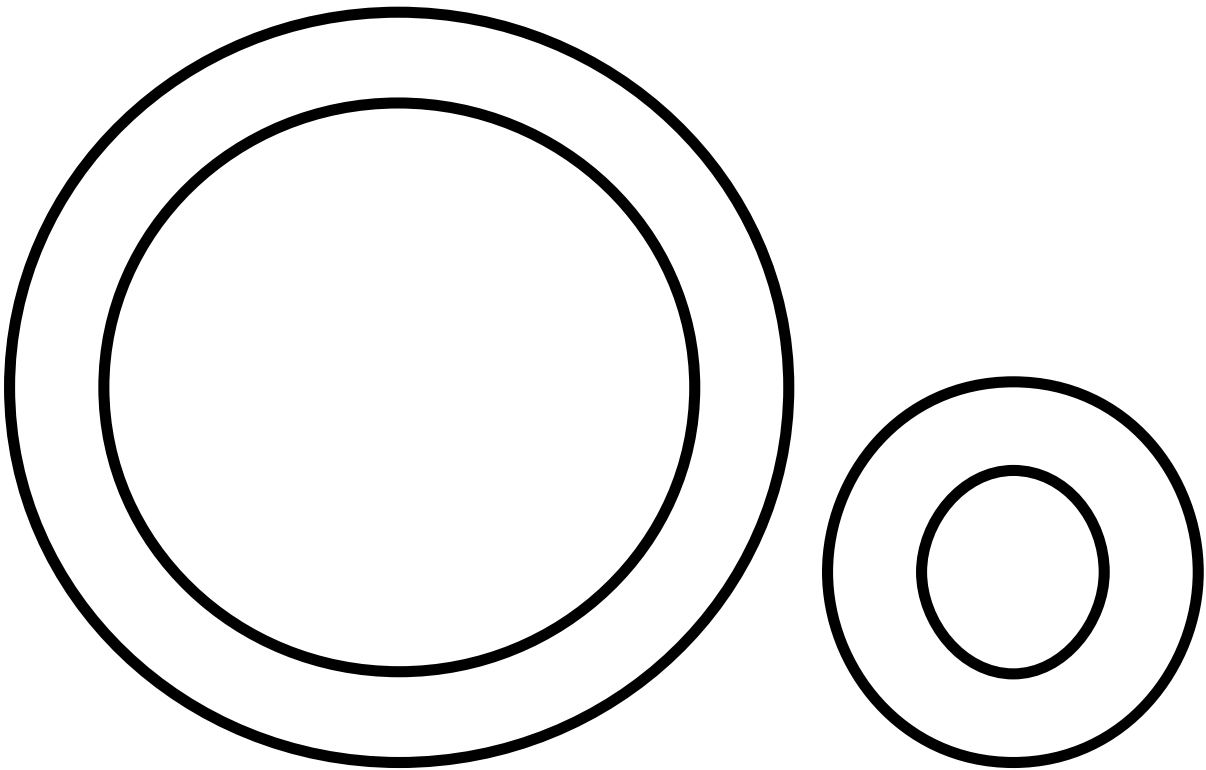

Alphabet Tracing

Letter Pairs: Oo

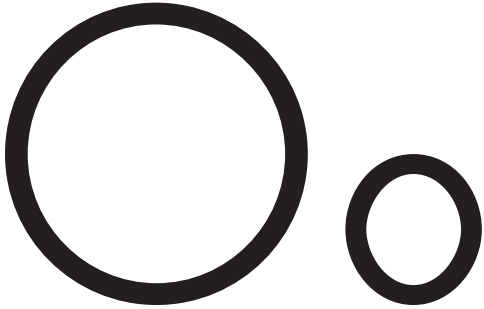

owl



Tracing practice area consisting of four rows of horizontal lines. The first row contains four dotted circles with arrows and a starting dot indicating the counter-clockwise stroke direction. The second row contains four dotted circles of varying sizes for tracing. The third row contains a dotted circle, a dotted circle, and two solid black dots. The fourth row contains three solid black dots.

Alphabet Tracing

Letter Pairs: Pp

Pp

pig

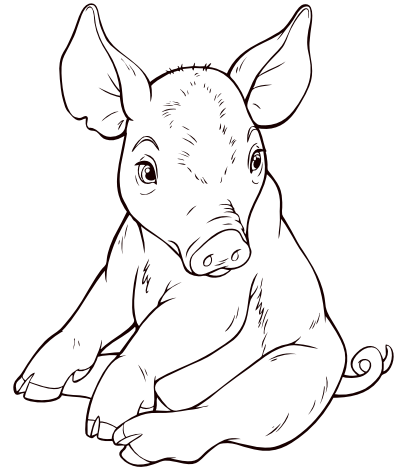

Tracing practice area with four rows of horizontal lines:

- Row 1: Six dotted uppercase 'P's and lowercase 'p's. Each letter has a starting dot and numbered arrows (1 and 2) indicating the stroke order.
- Row 2: Six dotted uppercase 'P's and lowercase 'p's for tracing.
- Row 3: A dotted uppercase 'P' and lowercase 'p' for tracing, followed by four solid black dots on the top line and four solid black dots on the middle line.
- Row 4: Four solid black dots on the top line and four solid black dots on the middle line.

Alphabet
Letter Coloring: **Pp**

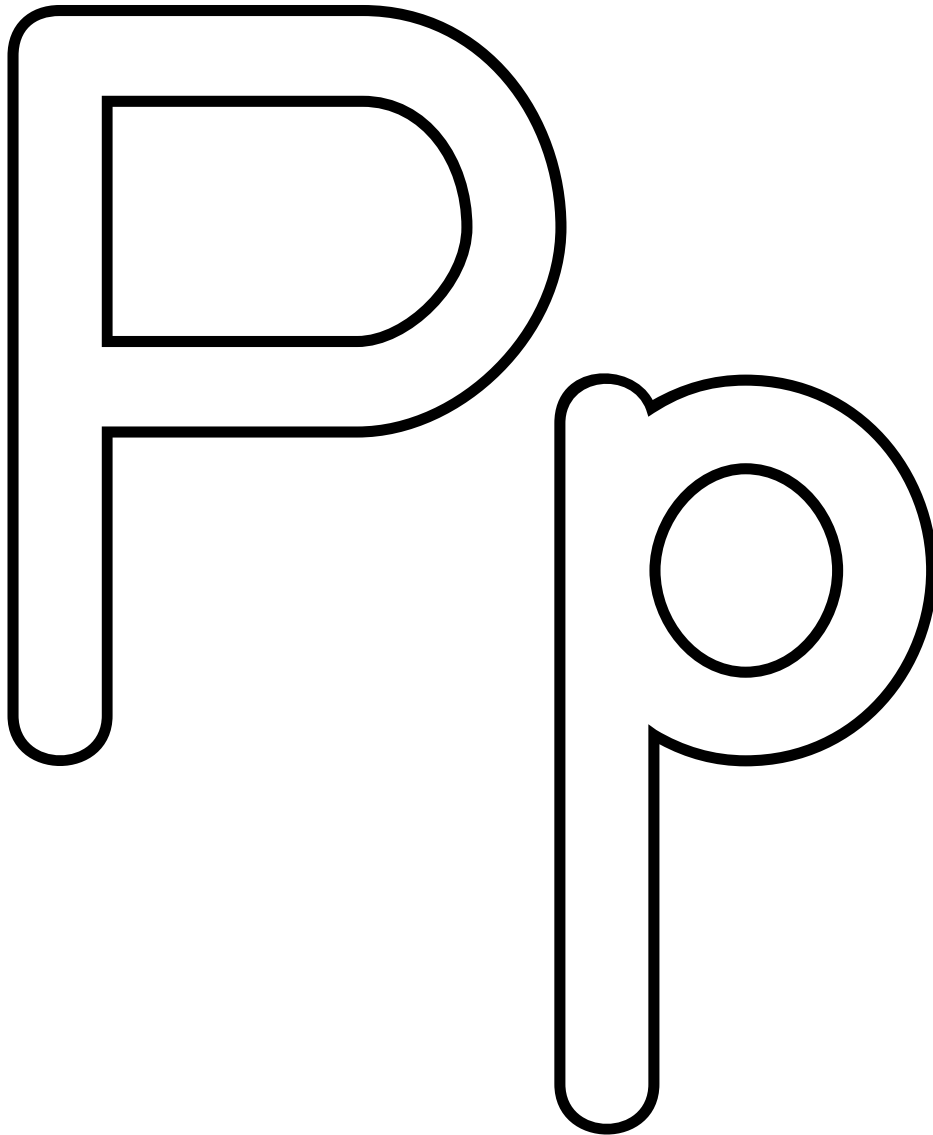

Alphabet Tracing

Letter Pairs: Qq

Qq

queen



Tracing practice area with four rows of handwriting lines. The first row shows dotted letters Q and q with numbered arrows indicating stroke order: 1 for the counter-clockwise circle and 2 for the diagonal tail. The second row shows dotted Q and q for tracing. The third row shows a dotted Q, a dotted q, and two solid black dots on the middle line. The fourth row shows a solid black dot on the bottom line, a dotted q, a solid black dot on the middle line, and a solid black dot on the bottom line.

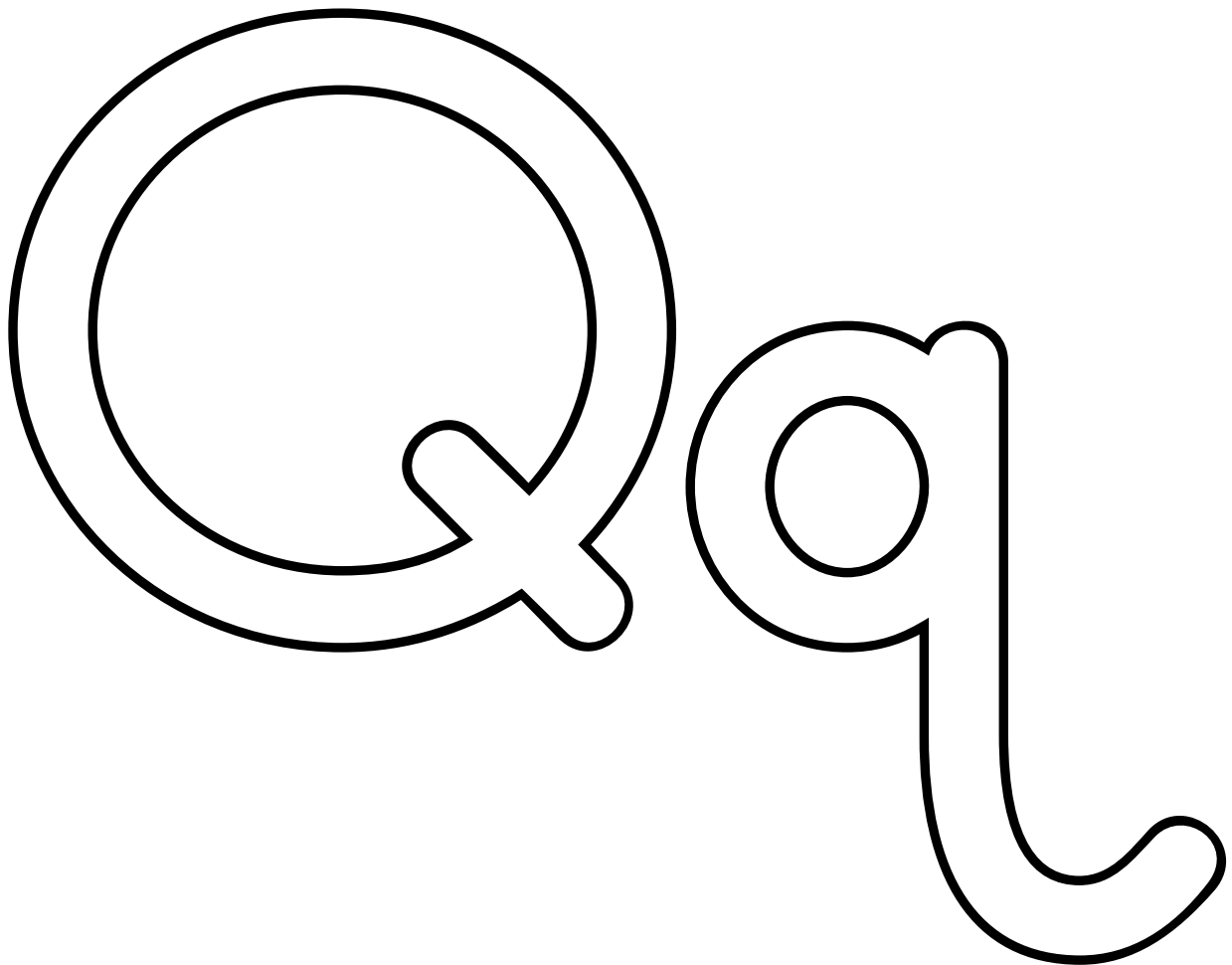

Alphabet Tracing

Letter Pairs: Rr

Rr

robot

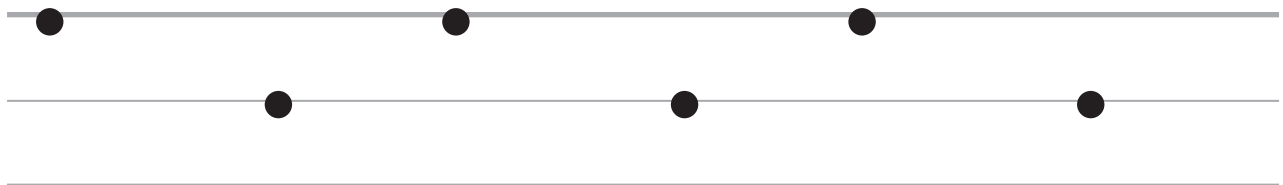
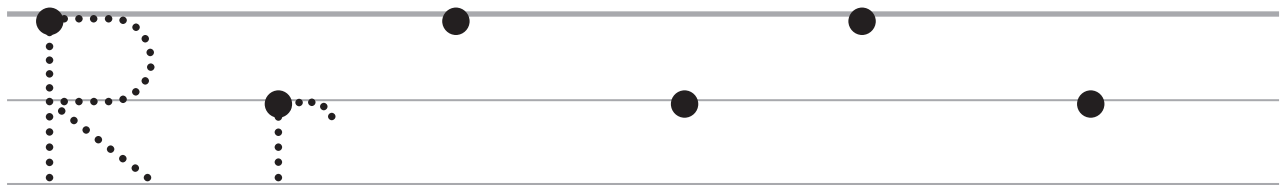
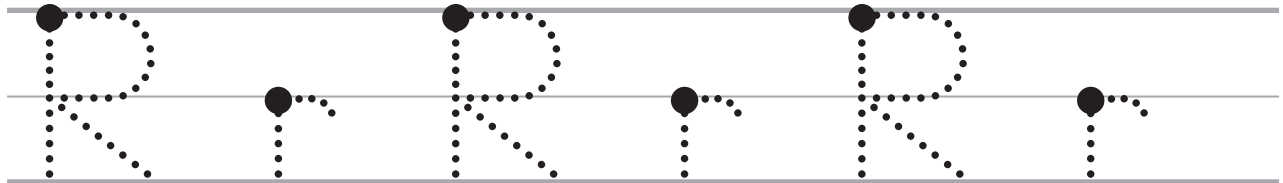
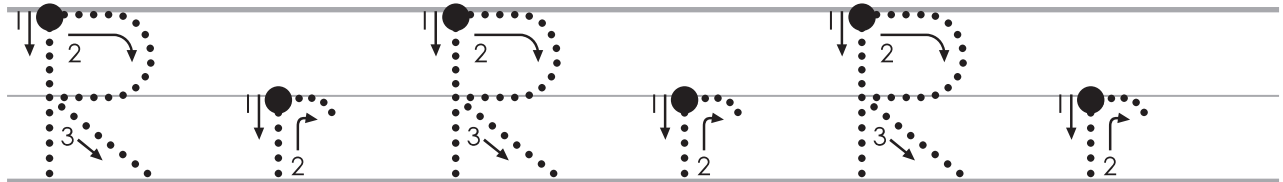
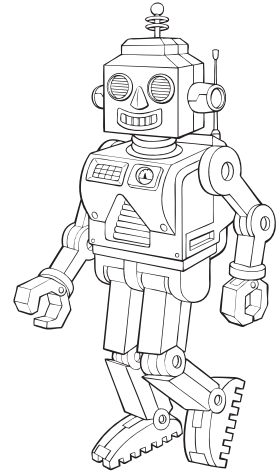



Alphabet Tracing

Letter Pairs: Ss

Ss

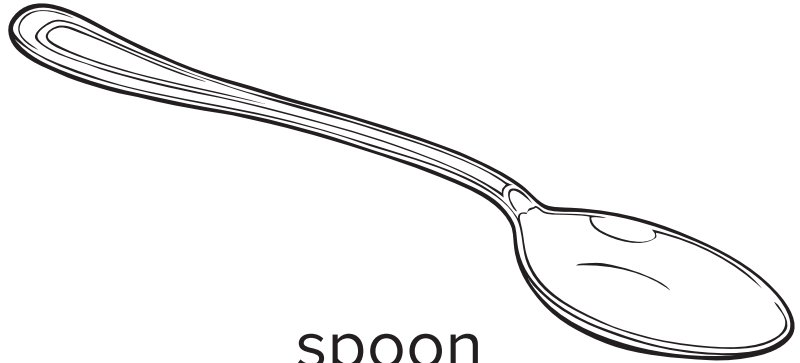

spoon

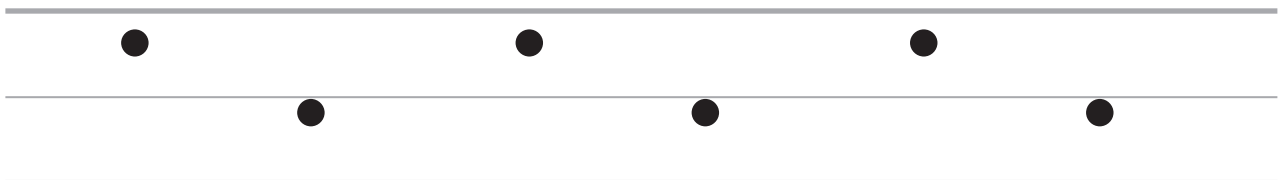
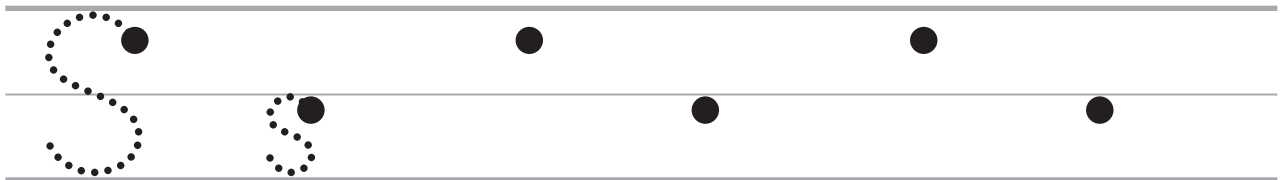
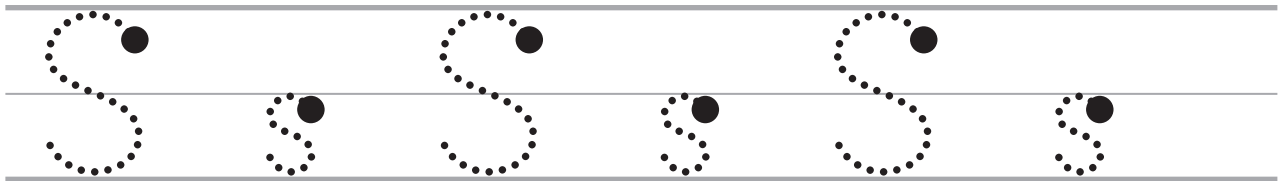
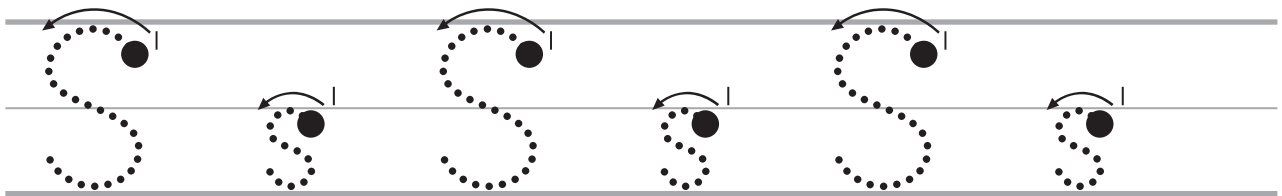

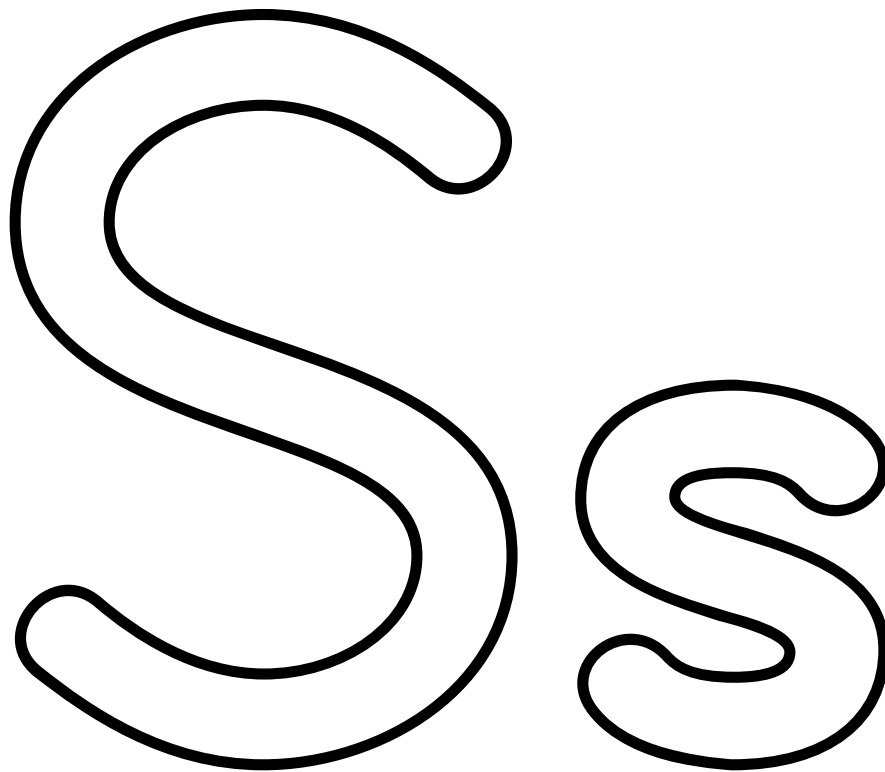

Alphabet Tracing

Letter Pairs: Tt



tent

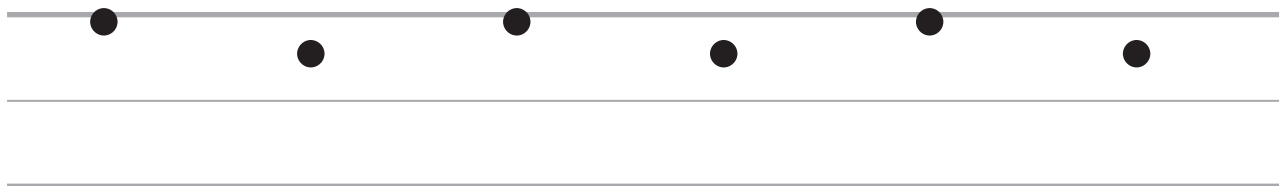
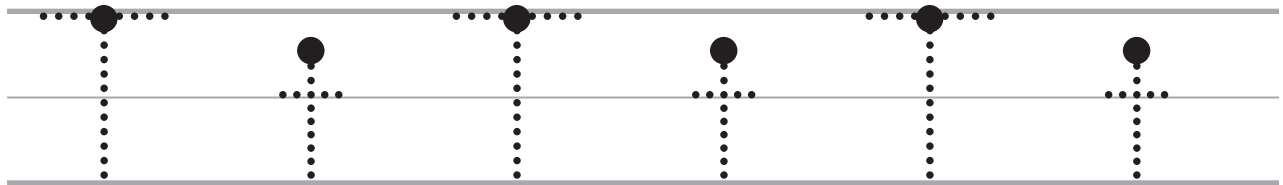
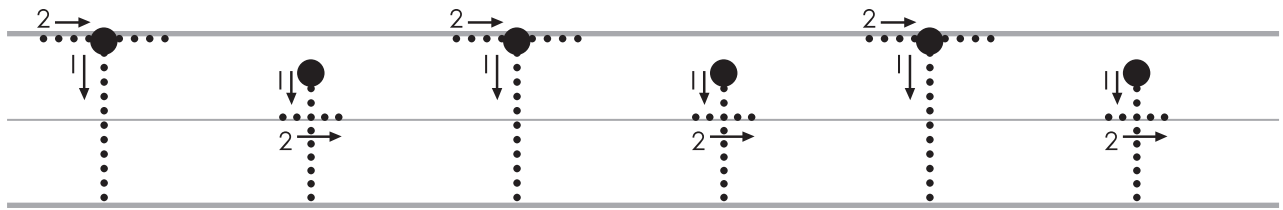

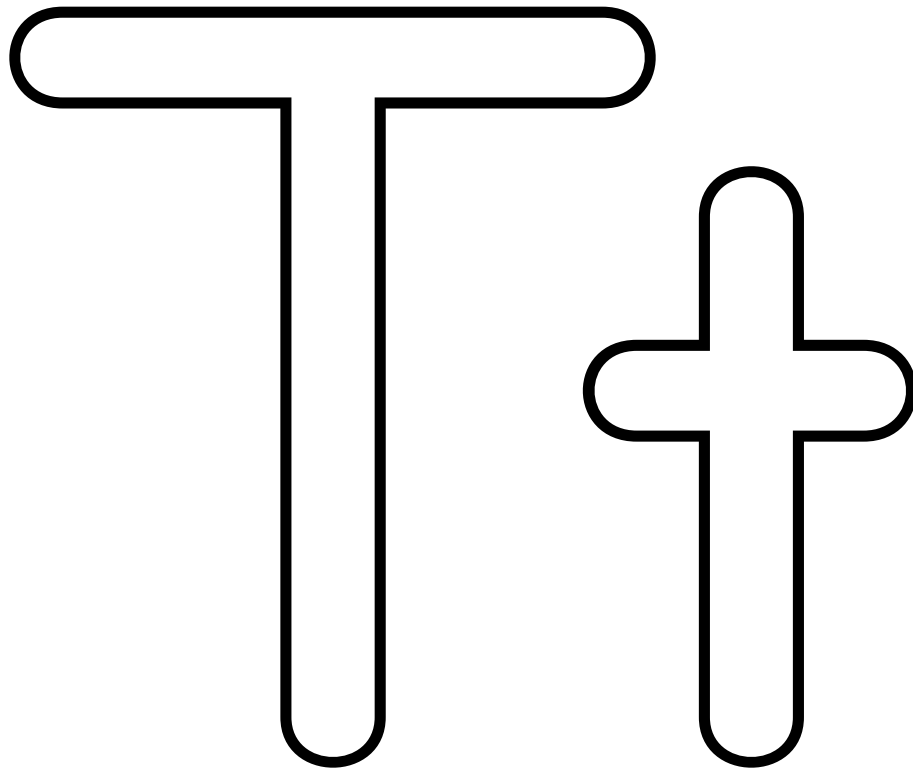

Alphabet Tracing

Letter Pairs: Uu

Uu

unicycle

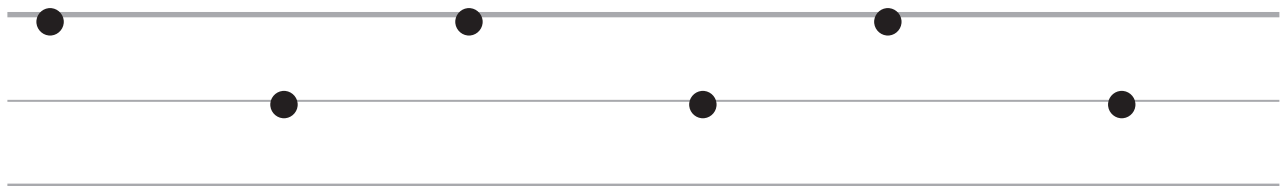
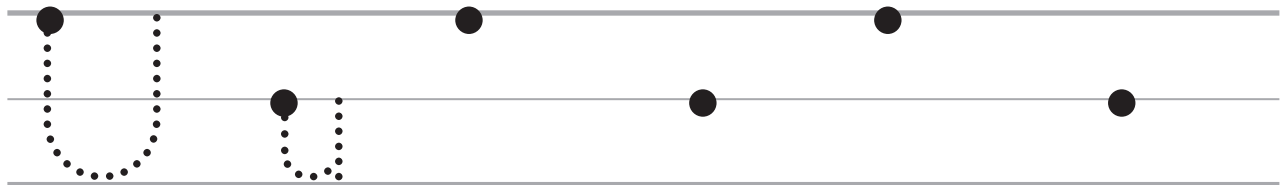
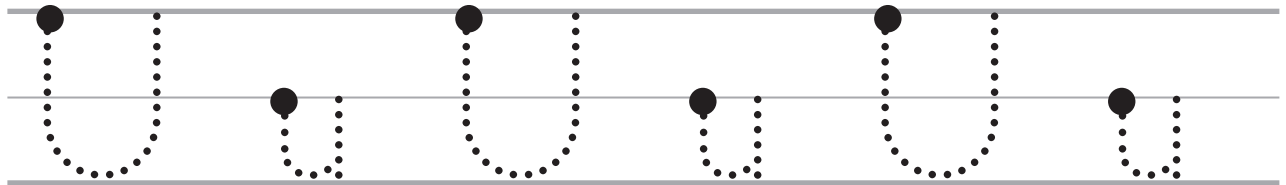
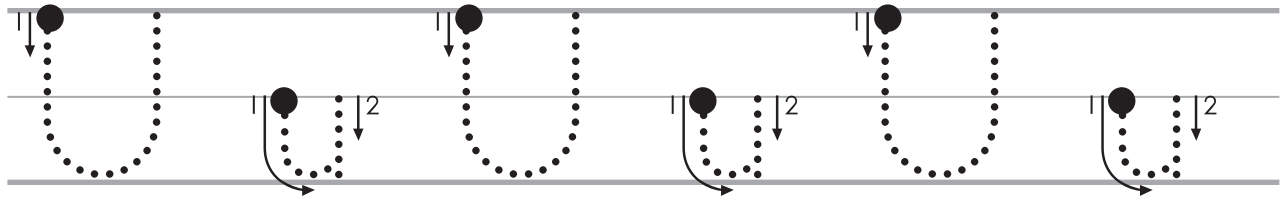
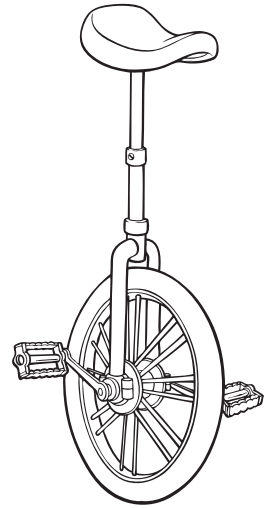

Alphabet
Letter Coloring: **Uu**

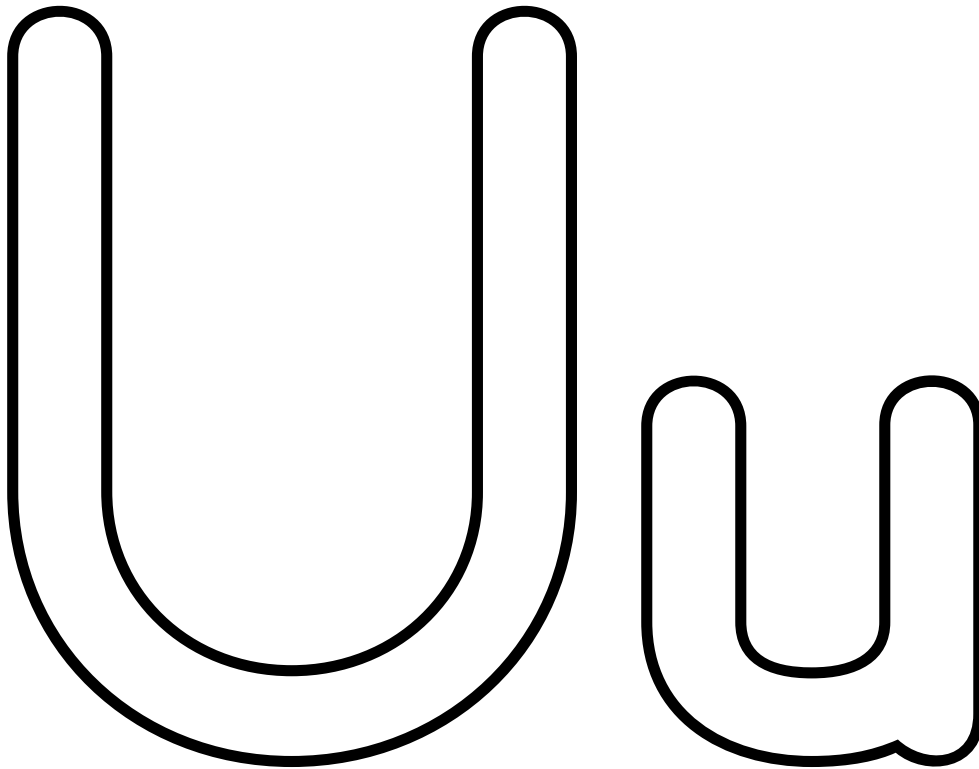

Alphabet
Letter Coloring: **Vv**



Alphabet Tracing

Letter Pairs: Vv

V v

vacuum

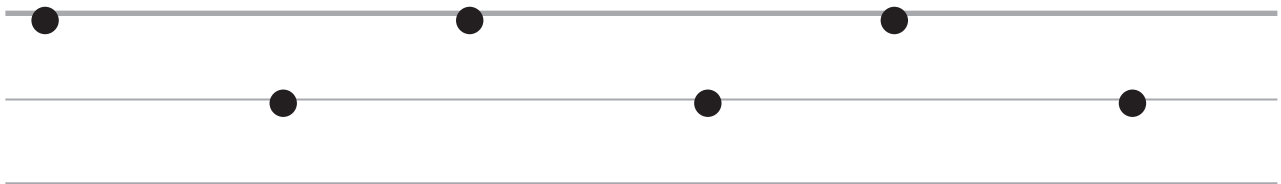
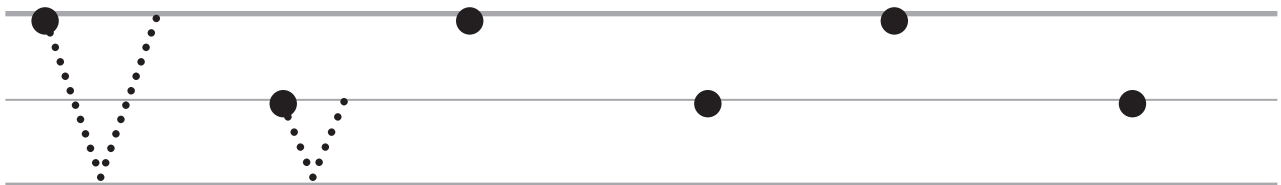
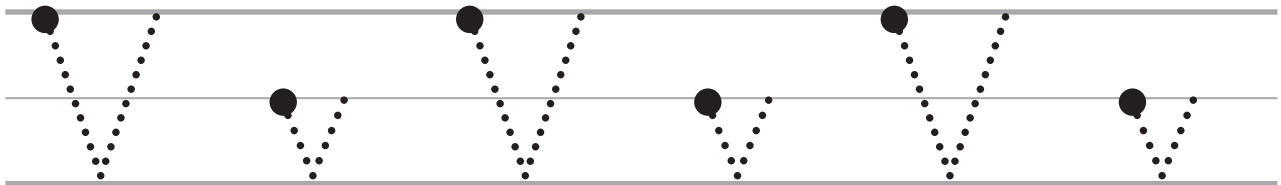
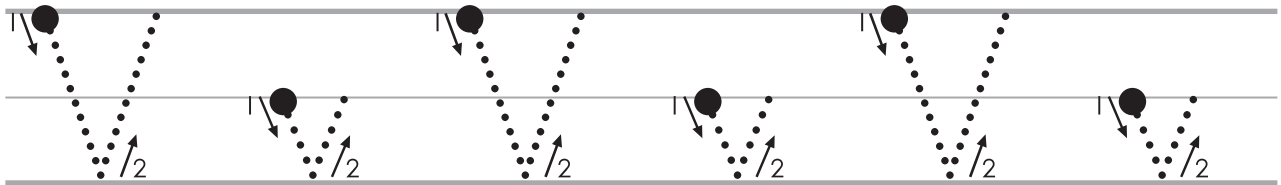
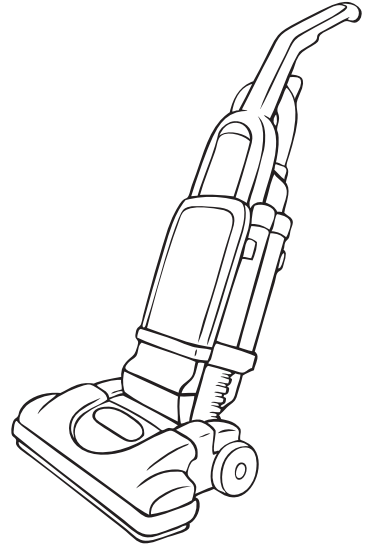

Alphabet Tracing

Letter Pairs: Ww



windmill

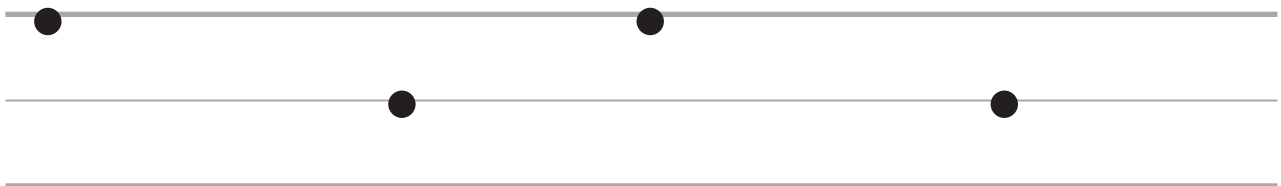
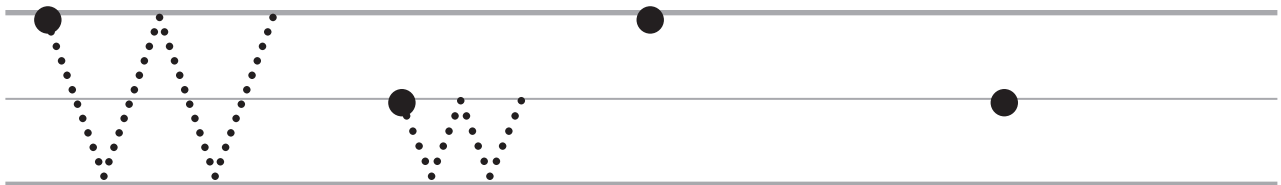
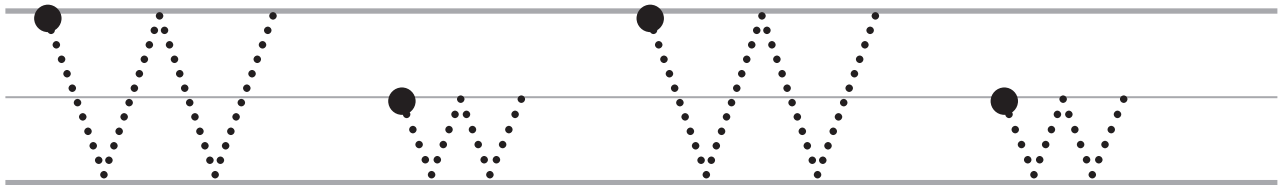
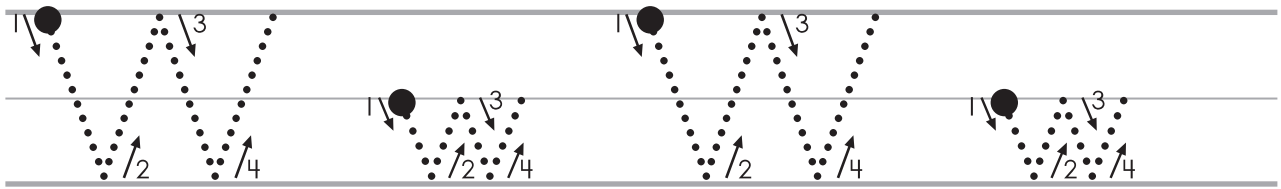
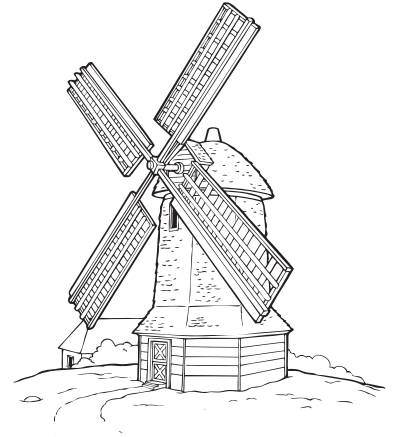

Alphabet
Letter Coloring: **Ww**



Alphabet Tracing

Letter Pairs: Xx

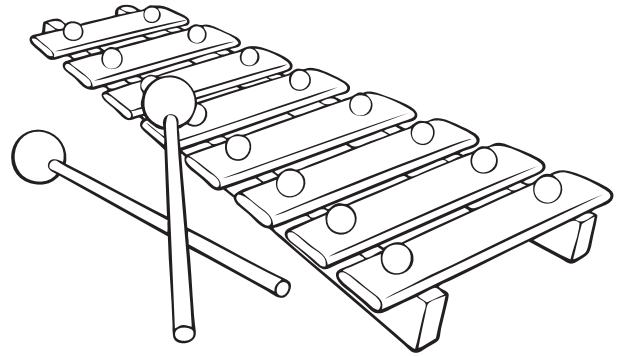

xylophone

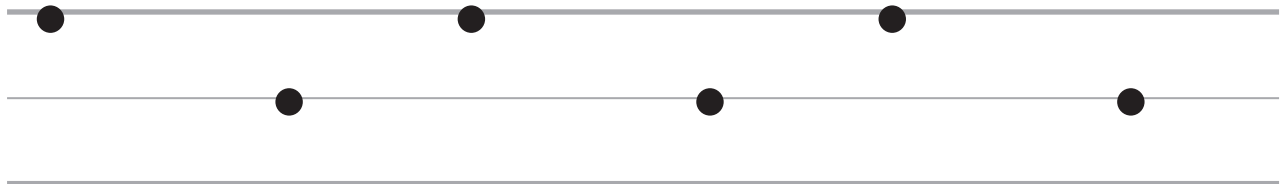
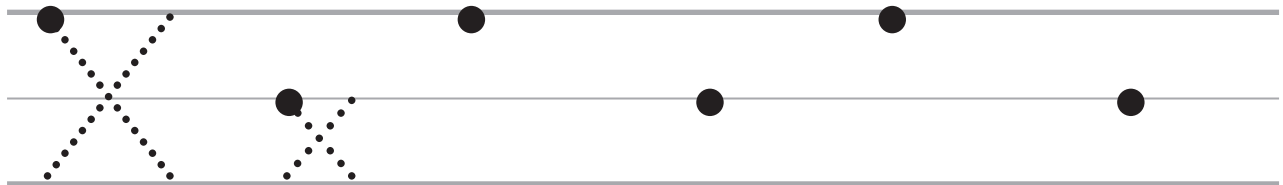
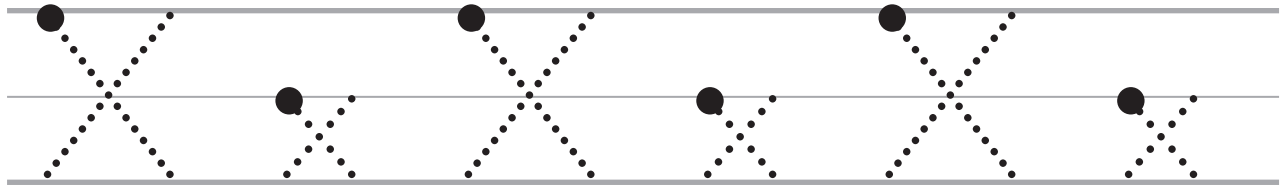
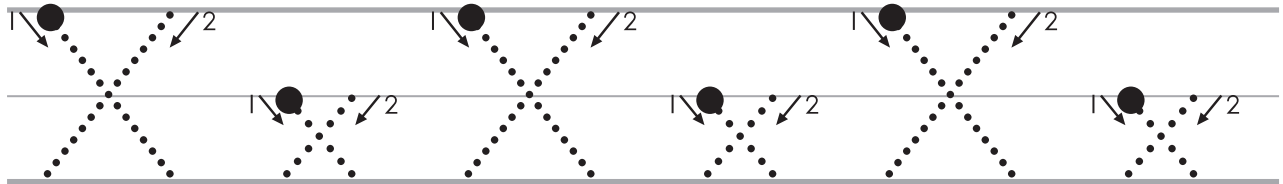

Alphabet
Letter Coloring: **Xx**

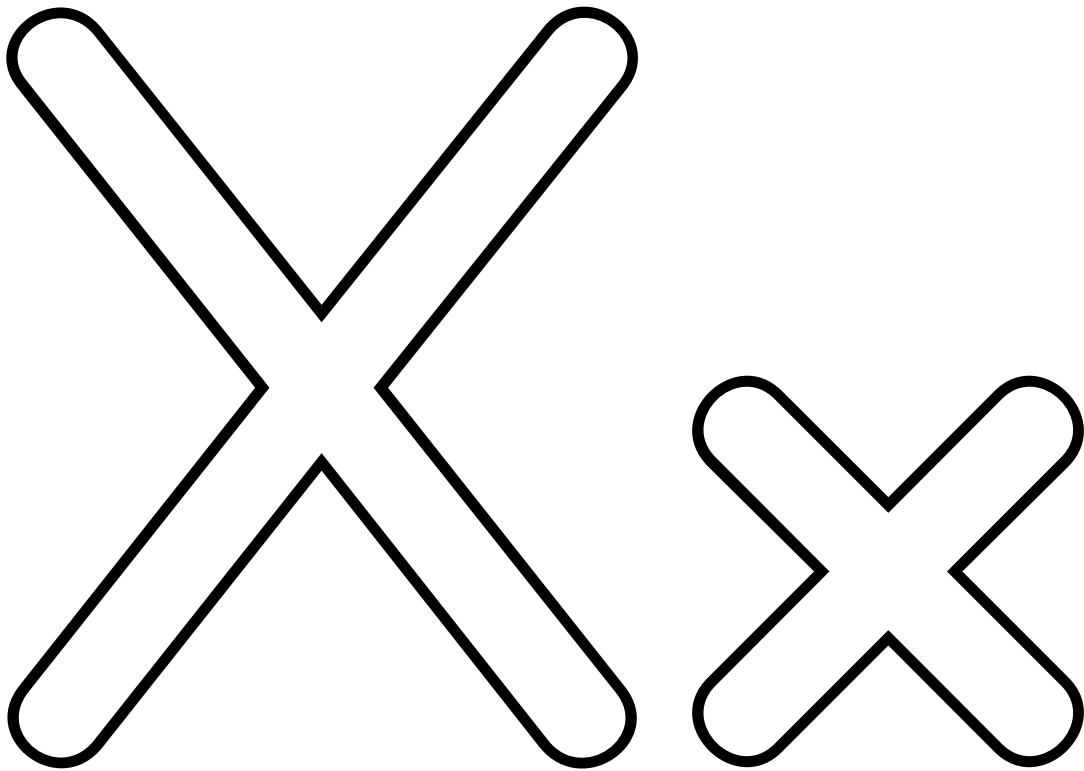

Alphabet Tracing

Letter Pairs: Yy



yak

Tracing practice area consisting of four rows of horizontal lines. The first row shows three uppercase 'Y's and two lowercase 'y's, each with numbered arrows (1, 2, 3) indicating the stroke order. The second row contains five dotted uppercase 'Y's and five dotted lowercase 'y's for tracing. The third row contains one dotted uppercase 'Y' and one dotted lowercase 'y', followed by four solid black dots. The fourth row contains four solid black dots.

Alphabet
Letter Coloring: Yy

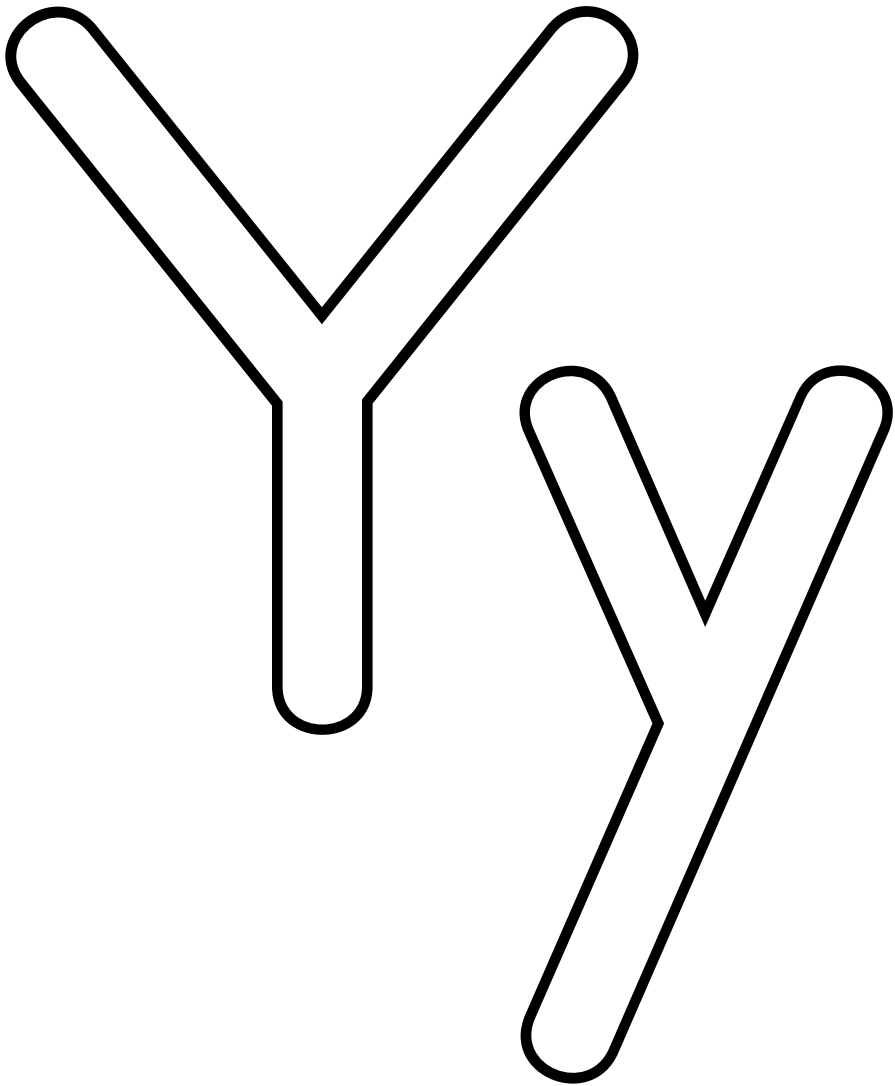

Alphabet Tracing

Letter Pairs: Zz

Zz

zipper

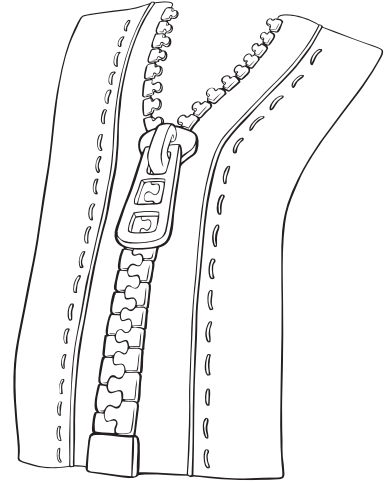

Tracing practice for uppercase Z and lowercase z. The first row shows six dotted letters with numbered arrows (1, 2, 3) indicating stroke order. The second row shows six dotted letters for tracing. The third row shows two dotted letters followed by four solid black dots for starting points. The fourth row shows four solid black dots for starting points. The fifth row shows four solid black dots for starting points.

Alphabet

Letter Coloring: Zz

